



HELVEX®

Garantía de Calidad

LISTA DE
PRECIOS

134-A
Julio 2023

ESTA LISTA DE PRECIOS PERTENECE A:

NOMBRE:

TIENDA:

DESCARGA LA **LP 134-A** AQUÍ



HELVEX

Garantía de Calidad



POR 73 AÑOS hemos mantenido la filosofía de fabricar todos nuestros productos, lo cual nos ha permitido llevar los estándares de calidad a niveles más altos, asegurándonos de ofrecerte la máxima experiencia en innovación, diseño, funcionamiento y durabilidad. Cada producto que desarrollamos es sometido a estrictas pruebas con el objetivo de que al usarlos, disfrutes una gran sensación de confort.

NUESTRA VOCACIÓN de ser fabricantes es lo que nos distingue y nos llena de mucho orgullo, porque con ella, año con año refrendamos nuestro compromiso hacia la innovación y la calidad, lo cual nos ha permitido llegar a otros países y conquistar la confianza de miles de personas, comercializando nuestros productos en más de 20 naciones, exportando nuestro lema de garantía de calidad a Estados Unidos, Canadá, Centroamérica, Sudamérica y el Caribe.

EN TODOS ESTOS AÑOS DE HISTORIA, hemos aprendido que lo más importante es brindarte el servicio más eficiente en asesoría, capacitación y servicio técnico especializado antes, durante y después de la compra. Por eso, día con día trabajamos para ofrecerte el mayor y mejor respaldo, tanto en garantía como en refacciones originales, que aseguren que tu Helvex siempre funcione.

Detrás de lo funcional y armonioso de los productos que creamos, existe un equipo de mujeres y hombres mexicanos, unidos por una regla de excelencia.

**- Ofrecer la máxima calidad -
Helvex, 73 años de ser la llave de México**

HELVEX

Garantía de Calidad



**DESCARGA
EL FOLLETO
DE NUEVOS
PRODUCTOS**



HELVEX

De la mano de Gald

**NUEVOS
PRODUCTOS
2023**



ÍNDICE



MANERALES

19

MEZCLADORAS Y MONOMANDOS

25

COMPLEMENTOS PARA LAVABO

53

ACCESORIOS

59

COCINA

105

REGADERAS

121

SALIDAS PARA TINA

159

COLADERAS

163

LLAVES PARA HOSPITAL

183



**LLAVES
ECONOMIZADORAS**

187

**LLAVES
ELECTRÓNICAS**

191

**ACONDICIONADOR
DE AGUAS DURAS**

197

**ACCESORIOS
INSTITUCIONALES**

199

FLUXÓMETROS

207

**MUEBLES SANITARIOS
Y LAVABOS**

217

**PAQUETES
INSTITUCIONALES**

255

ÍNDICE ALFANUMÉRICO

MODELO	DESCRIPCIÓN	PRECIO	PÁGINA
17	Portapapel con repisa para celular	\$ 1,486.00	102
22	Coladera corta de una boca lateral, de rejilla redonda removible	\$ 1,772.00	164
24	Coladera de una boca, de rejilla redonda	\$ 1,772.00	167
25	Coladera de tres bocas, rejilla redonda	\$ 1,972.00	172
26	Coladera de tres bocas, con tapa ciega redonda	\$ 2,032.00	174
27	Coladera alta de una boca, rejilla redonda de 25 cm	\$ 2,314.00	170
28	Coladera alta de tres bocas, rejilla redonda de 25 cm	\$ 2,472.00	174
34	Clásica. Portapapel vertical y/o de repuesto	\$ 1,517.00	65
100	Clásica. Jabonera de empotrar con agarradera	\$ 1,910.00	65
101	Clásica. Jabonera de empotrar con agarradera	\$ 1,717.00	65
104	Clásica. Portapapel de empotrar	\$ 1,730.00	66
105	Clásica. Toallero de barra	\$ 2,224.00	66
105-45	Clásica. Toallero de barra de 45 cm	\$ 2,072.00	66
106	Clásica. Gancho doble	\$ 743.00	66
107	Clásica. Portavaso cepillero	\$ 946.00	67
108	Clásica. Jabonera	\$ 1,096.00	67
109	Clásica. Toallero de argolla	\$ 1,099.00	67
110	Clásica. Portatoallas múltiple	\$ 4,457.00	68
114	Clásica. Portapapel de empotrar con cubierta	\$ 2,458.00	68
115	Clásica. Portapapel de empotrar con tubo antirrobo	\$ 2,086.00	68
117	Clásica. Portapapel	\$ 1,527.00	69
122	Clásica. Tendadero retráctil, longitud 3.25 m	\$ 1,840.00	69
123	Clásica. Destapador	\$ 696.00	69
124	Clásica. Portatoallas múltiple con toallero	\$ 5,650.00	69
158	Clásica. Agarradera para tina con jabonera de rejilla	\$ 4,788.00	70
205	Clásica II. Toallero de barra	\$ 2,224.00	71
205-45	Clásica II. Toallero de barra de 45 cm	\$ 2,072.00	71
206	Clásica II. Gancho doble	\$ 743.00	71
207	Clásica II. Portacepillos	\$ 946.00	71
208	Clásica II. Jabonera	\$ 1,092.00	72
209	Clásica II. Toallero de argolla	\$ 1,099.00	72
210	Clásica II. Portatoallas múltiple	\$ 4,457.00	72
215	Clásica II. Portapapel con tubo antirrobo	\$ 2,098.00	73
217	Clásica II. Portapapel	\$ 1,527.00	73
219	Clásica II. Portapapel doble con tubos antirrobo	\$ 3,359.00	73
223	Clásica II. Destapador	\$ 692.00	73
266	Clásica. Gancho multiusos reforzado	\$ 968.00	70
444	Coladera de cúpula para azotea	\$ 1,888.00	177
2104	Konos. Portapapel	\$ 1,448.00	84
2105	Konos. Toallero de barra	\$ 2,332.00	84
2106	Konos. Gancho doble	\$ 941.00	84
2107	Konos. Portacepillos	\$ 1,581.00	84
2108	Konos. Jabonera	\$ 1,602.00	85
2109	Konos. Toallero sencillo	\$ 1,527.00	85
2514	Coladera de rejilla redonda con campana	\$ 2,902.00	176
2584	Coladera de rejilla cuadrada, de acero inoxidable con campana	\$ 8,436.00	176
2714	Coladera de rejilla rectangular con campana	\$ 6,959.00	176
4954	Coladera de pretil para azotea	\$ 2,850.00	177
5424	Coladera de rejilla redonda, con canastilla para sedimentos	\$ 3,195.00	176
9105	Nuva. Toallero de barra	\$ 3,832.00	78
9106	Nuva. Gancho sencillo	\$ 1,501.00	78
9107	Nuva. Vaso cepillero de cristal	\$ 3,094.00	78

ÍNDICE ALFANUMÉRICO

MODELO	DESCRIPCIÓN	PRECIO	PÁGINA
9109	Nuva. Toallero corto	\$ 2,374.00	78
9117	Nuva. Portapapel	\$ 1,776.00	80
9124	Nuva. Portatoallas múltiple con toallero	\$ 5,890.00	80
9126	Nuva. Repisa de cristal de 60 cm	\$ 5,351.00	81
9128	Nuva. Jabonera	\$ 2,965.00	81
14104	Kúbica. Portapapel	\$ 1,898.00	86
14105	Kúbica. Toallero de barra	\$ 4,135.00	86
14106	Kúbica. Gancho doble	\$ 1,608.00	86
14107	Kúbica. Portacepillos	\$ 2,377.00	87
14108	Kúbica. Jabonera	\$ 3,181.00	87
14109	Kúbica. Toallero sencillo	\$ 2,545.00	87
15104	Premier. Portapapel	\$ 1,769.00	74
15105	Premier. Toallero de barra	\$ 3,166.00	74
15106	Premier. Gancho sencillo	\$ 773.00	74
15107	Premier. Portacepillos	\$ 1,595.00	74
15108	Premier. Jabonera	\$ 2,123.00	75
15109	Premier. Toallero sencillo	\$ 1,708.00	75
16104	Vértika. Portapapel	\$ 1,832.00	94
16105	Vértika. Toallero de barra	\$ 4,003.00	94
16106	Vértika. Gancho doble	\$ 1,544.00	94
16107	Vértika. Portacepillos	\$ 2,574.00	95
16108	Vértika. Jabonera	\$ 2,574.00	95
16109	Vértika. Toallero sencillo	\$ 2,445.00	95
20105	Máxima. Toallero de barra	\$ 3,166.00	88
20105-EB	◀ NUEVO Máxima. Toallero de barra	\$ 3,640.00	90
20106	Máxima. Gancho sencillo	\$ 773.00	88
20106-EB	◀ NUEVO Máxima. Gancho sencillo	\$ 889.00	90
20109	Máxima. Toallero sencillo	\$ 1,708.00	89
20109-EB	◀ NUEVO Máxima. Toallero sencillo	\$ 1,965.00	90
20117	Máxima. Portapapel	\$ 1,769.00	89
20117-EB	◀ NUEVO Máxima. Portapapel	\$ 2,034.00	90
110-38	Flujómetro de manija para taza flux, spud de 38 mm. 6 L por descarga	\$ 7,604.00	207
110-38-3.5	◀ ECOFLUX Fluxómetro de manija para taza flux Nao, Nao17 y Nao a pared. 3.5 L por descarga	\$ 7,604.00	207
110-WC-4.8	◀ ECOFLUX Fluxómetro de manija para taza flux, spud de 38 mm. 4.8 L por descarga	\$ 7,604.00	207
117-38	Flujómetro de manija para taza flux, spud de 38 mm. 6 L por descarga	\$ 8,008.00	207
1342-35-CHL	Coladera de tres bocas, desagüe de contorno cuadrado	\$ 4,408.00	174
1342-35-CHLI	Coladera de tres bocas, desagüe de contorno cuadrado	\$ 4,408.00	174
1342-35CH	Coladera de tres bocas, rejilla cuadrada	\$ 3,800.00	175
1342-H	Coladera de tres bocas, rejilla redonda	\$ 2,822.00	175
1342-HL	Coladera de tres bocas, desagüe de contorno redondo	\$ 3,409.00	175
1342-HLI	Coladera de tres bocas, desagüe de contorno redondo	\$ 3,409.00	175
15104-EB	Premier. Portapapel	\$ 2,032.00	76
15105-EB	Premier. Toallero de barra	\$ 3,641.00	76
15106-EB	Premier. Gancho sencillo	\$ 889.00	76
15107-EB	Premier. Portacepillos	\$ 1,822.00	76
15108-EB	Premier. Jabonera	\$ 2,440.00	77
15109-EB	Premier. Toallero sencillo	\$ 1,963.00	77
185-19	Flujómetro de manija para mingitorio. 3 L por descarga	\$ 7,604.00	210
185-19-0.5	◀ ECOFLUX Fluxómetro de manija para mingitorio. 0.5 L por descarga	\$ 7,604.00	210
185-19-1	Flujómetro de manija para mingitorio. 1 L por descarga	\$ 7,604.00	210
22-CH	Coladera corta de una boca lateral, de rejilla cuadrada removible	\$ 1,939.00	164
22-CHL	Coladera corta de una boca lateral, desagüe de contorno cuadrado	\$ 2,248.00	164

ÍNDICE ALFANUMÉRICO

MODELO	DESCRIPCIÓN	PRECIO	PÁGINA
22-CHLI	Coladera corta de una boca lateral, desagüe de contorno cuadrado	\$ 2,248.00	164
22-HL	Coladera corta de una boca lateral, desagüe de contorno redondo	\$ 2,087.00	165
22-HLI	Coladera corta de una boca lateral, desagüe de contorno redondo	\$ 2,087.00	165
22V	Coladera corta de una boca vertical, de rejilla redonda removible	\$ 1,772.00	165
22V-CH	Coladera corta de una boca vertical, de rejilla redonda removible	\$ 1,939.00	166
22V-CHL	Coladera corta de una boca vertical, desagüe de contorno cuadrado	\$ 2,248.00	166
22V-CHLI	Coladera corta de una boca vertical, desagüe de contorno cuadrado	\$ 2,248.00	166
22V-HL	Coladera corta de una boca vertical, desagüe de contorno redondo	\$ 2,087.00	167
22V-HLI	Coladera corta de una boca vertical, desagüe de contorno redondo	\$ 2,087.00	167
24-CH	Coladera de una boca, de rejilla cuadrada	\$ 1,939.00	168
24-CHL	Coladera de una boca, tapa redonda desagüe de contorno cuadrado	\$ 2,248.00	168
24-CHLI	Coladera de una boca, desagüe de contorno cuadrado	\$ 2,248.00	168
24-HL	Coladera de una boca, desagüe de contorno tapa redonda	\$ 2,087.00	169
24-HLI	Coladera de una boca, desagüe de contorno redondo	\$ 2,087.00	169
24-RHLI	Coladera rectangular de una boca, desagüe de contorno rectangular	\$ 5,139.00	169
24-RHLI-60	Coladera decorativa alargada de 60 cm	\$ 7,829.00	170
24-RHLI-90	Coladera decorativa alargada de 90 cm	\$ 10,277.00	170
25-CH	Coladera de tres bocas, rejilla cuadrada	\$ 2,128.00	172
25-CHL	Coladera de tres bocas, desagüe de contorno cuadrado	\$ 2,442.00	173
25-CHLI	Coladera cuadrada de tres bocas, desagüe de contorno	\$ 2,442.00	173
25-HL	Coladera de tres bocas, desagüe de contorno rejilla redonda	\$ 2,282.00	173
25-HLI	Coladera de tres bocas, desagüe de contorno redondo	\$ 2,282.00	173
282-35-CHL	Coladera de una boca desagüe de contorno cuadrado	\$ 5,139.00	171
282-35-CHLI	Coladera de una boca, desagüe de contorno cuadrado	\$ 5,139.00	171
282-35CH	Coladera de una boca, rejilla cuadrada	\$ 4,515.00	171
282-H	Coladera de una boca, rejilla redonda	\$ 3,315.00	171
282-HL	Coladera redonda de una boca, desagüe de contorno	\$ 3,908.00	172
282-HLI	Coladera de una boca, desagüe de contorno redondo	\$ 3,908.00	172
310-19	Fluxómetro de pedal expuesto para mingitorio, spud de 19 mm, 3 L por descarga	\$ 9,146.00	209
310-19-0.5 <small>ECOINDEX</small>	Fluxómetro de pedal expuesto para mingitorio, spud de 19 mm, 0.5 L por descarga	\$ 9,146.00	209
310-19-1	Fluxómetro de pedal expuesto para mingitorio, spud de 19 mm, 1 L por descarga	\$ 9,146.00	209
310-38	Fluxómetro de pedal expuesto para taza flux, spud de 38 mm, 6 L por descarga	\$ 9,146.00	208
310-38-3.5 <small>ECOINDEX</small>	Fluxómetro de pedal expuesto para taza flux, spud de 38 mm, 3.5 L por descarga	\$ 9,146.00	208
310-WC-4.8 <small>ECOINDEX</small>	Fluxómetro de pedal expuesto para taza flux, spud de 38 mm, 4.8 L por descarga	\$ 9,146.00	208
312-WC-4.8 <small>ECOINDEX</small>	Fluxómetro de pedal expuesto para taza flux cuerpo oculto, 4.8 L por descarga	\$ 9,127.00	211
342-C	Rebosadero de rejilla cuadrada	\$ 1,168.00	178
342-CL	Rebosadero con desagüe de contorno cuadrado	\$ 1,340.00	178
342-R	Rebosadero de rejilla redonda	\$ 997.00	178
342-RL	Rebosadero con desagüe de contorno redondo	\$ 1,139.00	179
444-X	Coladera de cúpula para azotea	\$ 1,888.00	177
446-X	Coladera de cúpula para azotea	\$ 3,837.00	177
632-H	Rebosadero de rejilla rectangular de acero inoxidable	\$ 2,625.00	179
AC-110	Regadera de limpieza automática. Antirrobo con base al muro	\$ 3,320.00	127
AC110-8 <small>ECOINDEX</small>	Regadera de limpieza automática. Antirrobo con base al muro	\$ 3,320.00	127
AC10-TR011	Regadera de limpieza automática con válvula de control	\$ 2,974.00	126
AC20-TR011	Regadera de limpieza automática con válvula de control	\$ 3,777.00	126
AC50-TR011	Regadera de limpieza automática sin válvula de control	\$ 2,611.00	127
ACC-105	Access. Toallero de barra	\$ 2,046.00	59
ACC-105-B	Access. Toallero de barra	\$ 2,352.00	61
ACC-105-EB	Access. Toallero de barra	\$ 2,352.00	63
ACC-106	Access. Gancho sencillo	\$ 709.00	59
ACC-106-B	Access. Gancho sencillo	\$ 814.00	61

ÍNDICE ALFANUMÉRICO

MODELO	DESCRIPCIÓN	PRECIO	PÁGINA
ACC-106-EB	Access. Gancho sencillo	\$ 814.00	63
ACC-107	Access. Portacepillos	\$ 933.00	59
ACC-107-B	Access. Portacepillos	\$ 1,072.00	61
ACC-107-EB	Access. Portacepillos	\$ 1,072.00	64
ACC-108	Access. Jabonera	\$ 1,020.00	59
ACC-108-B	Access. Jabonera	\$ 1,172.00	61
ACC-108-EB	Access. Jabonera	\$ 1,172.00	64
ACC-109	Access. Toallero sencillo	\$ 1,104.00	60
ACC-109-B	Access. Toallero sencillo	\$ 1,269.00	62
ACC-109-EB	Access. Toallero sencillo	\$ 1,269.00	64
ACC-117	Access. Portapapel	\$ 1,426.00	60
ACC-117-B	Access. Portapapel	\$ 1,640.00	62
ACC-117-EB	Access. Portapapel	\$ 1,640.00	64
AF-1	Asiento elongado para taza fluxómetro sin tapa	\$ 637.00	237
AF-2	Asiento plus elongado para taza fluxómetro sin tapa	\$ 1,271.00	237
AT-1	Asiento para WC elongado, frente abierto, cierre lento	\$ 1,160.00	232
AT-1-M	Asiento para WC elongado, frente abierto, cierre lento. Color marfil	\$ 1,160.00	232
AT-2	Asiento para WC, elongado, frente abierto, cierre estándar	\$ 736.00	232
AT-4	Asiento para WC elongado, con tapa envolvente, cierre lento	\$ 1,433.00	233
AT-5	Asiento para WC elongado, con tapa envolvente, cierre lento	\$ 1,160.00	233
ATE	Asiento electrónico. Incluye control remoto	\$ 24,936.00	234
ATM	Asiento tipo BIDEET mecánico	\$ 4,110.00	235
ATR-1	Asiento para WC redondo, frente abierto, cierre estándar	\$ 723.00	233
ATR-1-M	Asiento para WC redondo, frente abierto, cierre estándar. Color marfil	\$ 723.00	233
B-062-S	Barra angular Hockey 810 mm x 350 mm derecha Al	\$ 4,223.00	202
B-064-S	Barra angular Hockey 810 mm x 350 mm izquierda Al	\$ 4,223.00	202
B-066-S	Barra angular Boomerang 305 mm x 305 mm izquierda Al	\$ 3,167.00	202
B-305-S	Barra recta de seguridad 305 mm Al	\$ 1,860.00	200
B-470-S	Barra recta de seguridad 470 mm Al	\$ 1,860.00	200
B-610-S	Barra recta de seguridad 610 mm Al	\$ 1,971.00	200
B-700-S	Barra recta de seguridad 700 mm Al	\$ 2,021.00	200
BR-470	Barra de seguridad residencial antiderrapante	\$ 3,099.00	101
C-5	Flair. Juego de manerales grandes	\$ 1,371.00	19
C-12	Tritón. Juego de manerales grandes	\$ 1,390.00	19
C-14	Capri. Juego de manerales grandes	\$ 1,551.00	19
C-16	Rivoli. Juego de manerales grandes	\$ 1,551.00	19
C-20	Andros. Juego de manerales grandes	\$ 1,561.00	20
C-35	Tripoli. Juego de manerales grandes	\$ 1,551.00	20
C-37	Antiqua. Juego de manerales grandes	\$ 2,467.00	20
C-44	Antares. Juego de manerales grandes	\$ 1,447.00	20
C-45	Albatros. Juego de manerales grandes	\$ 1,447.00	21
C-46	Antea. Juego de manerales grandes	\$ 1,017.00	21
C-59	Ática. Juego de manerales grandes	\$ 1,447.00	21
C-62	Nuva. Juego de manerales grandes	\$ 2,862.00	21
C-65	Nuva. Juego de manerales grandes	\$ 2,862.00	22
C-67	Primma. Juego de manerales grandes	\$ 1,504.00	22
C-69	Kúbica. Juego de manerales grandes	\$ 2,982.00	22
C-70	Premier. Juego de manerales grandes	\$ 2,482.00	22
C-70-EB	Premier. Juego de manerales grandes	\$ 2,853.00	23
C-73	Konos. Juego de manerales grandes	\$ 2,482.00	23
E-300	Elite. Monomando para fregadero	\$ 5,573.00	110
E-300-EB	Elite. Monomando para fregadero	\$ 6,409.00	110

MÁXIMA
20105-EB
Ébano

\$ 3.640.00



Toallero de barra.



Dimensiones:
vista frontal

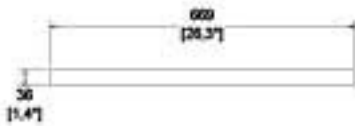

Dimensiones:
vista cenital

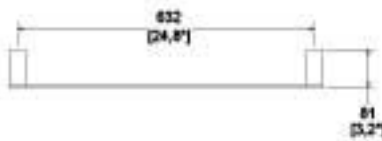

Acabado.

EB

MÁXIMA
20106-EB
Ébano

\$ 889.00



Gancho sencillo.



Dimensiones:
vista frontal

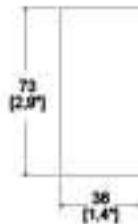

Dimensiones:
vista lateral

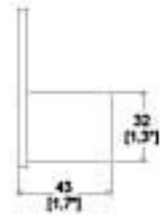

Acabado.

EB

MÁXIMA
20109-EB
Ébano

\$ 1.965.00



Toallero sencillo.



Dimensiones:
vista frontal

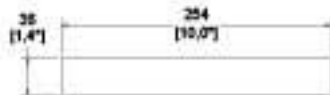

Dimensiones:
vista cenital



Acabado.

EB

MÁXIMA
20117-EB
Ébano

\$ 2.034.00



Portapapel.



Dimensiones:
vista frontal

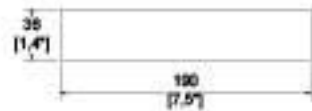

Dimensiones:
vista cenital



Acabado.

EB

PIAZZA CROMO

PIAZZA

PIA-105

Cromo

\$ 1.319.00

Toallero de barra.



Dimensiones:
vista frontal

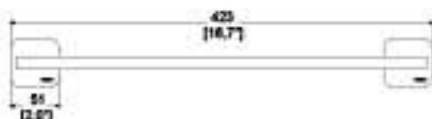

Dimensiones:
vista lateral

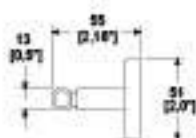

Acabado.



PIAZZA

PIA-106

Cromo

\$ 389.00

Gancho sencillo.



Dimensiones:
vista frontal

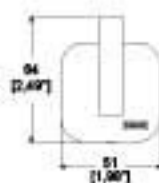

Dimensiones:
vista lateral

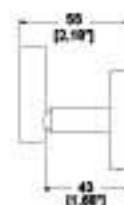

Acabado.



PIAZZA

PIA-109

Cromo

\$ 593.00

Toallero sencillo.



Dimensiones:
vista frontal

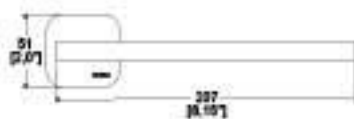

Dimensiones:
vista lateral

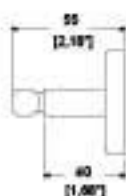

Acabado.



PIAZZA

PIA-117

Cromo

\$ 618.00

Portapapel.



Dimensiones:
vista frontal



Dimensiones:
vista lateral

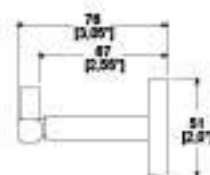

Acabado.



PIAZZA
PIA-105-EB
Ébano

\$ 1.517.00



Toallero de barra.



Dimensiones
vista frontal

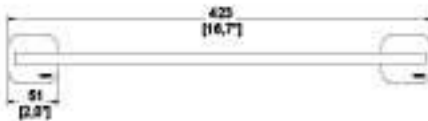

Dimensiones
vista lateral

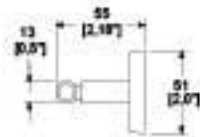

Acabado.



PIAZZA
PIA-106-EB
Ébano

\$ 447.00



Gancho sencillo.



Dimensiones
vista frontal

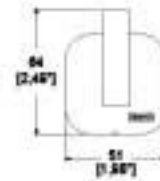

Dimensiones
vista lateral

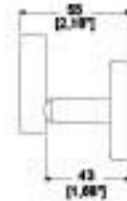

Acabado.



PIAZZA
PIA-109-EB
Ébano

\$ 682.00



Toallero sencillo.



Dimensiones
vista frontal



Dimensiones
vista lateral

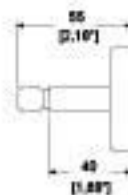

Acabado.



PIAZZA
PIA-117-EB
Ébano

\$ 711.00



Portapapel.



Dimensiones
vista frontal



Dimensiones
vista lateral

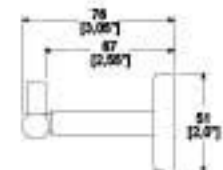

Acabado.



PIURA

PIU-05

Cromo

\$ 4.352.00

Toallero de barra.

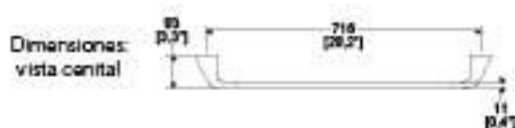
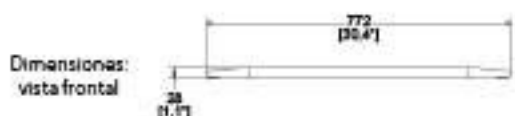

Acabado.



PIURA

PIU-06

Cromo

\$ 1.709.00

Gancho sencillo.



Dimensiones:
vista frontal



Dimensiones:
vista lateral

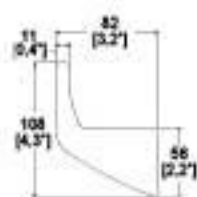

Acabado.



PIURA

PIU-09

Cromo

\$ 2.703.00

Toallero sencillo.

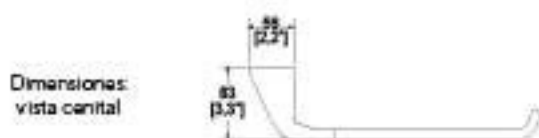
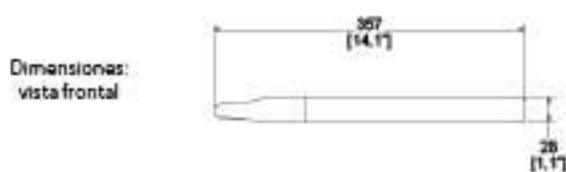

Acabado.



PIURA

PIU-17

Cromo

\$ 2.019.00

Portapapel.



Dimensiones:
vista frontal



Dimensiones:
vista cenital



Acabado.



VÉRTIKA

16104
Cromo

\$ 1.832.00

Portapapel.



Dimensiones:
vista frontal

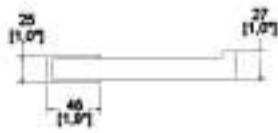

Dimensiones:
vista cenital

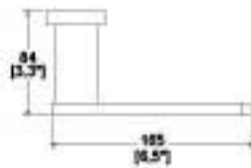

Acabado,



CR

VÉRTIKA

16105
Cromo

\$ 4.003.00

Toallero de barra.



Dimensiones:
vista frontal



Dimensiones:
vista cenital

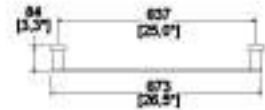

Acabado,



CR

VÉRTIKA

16106
Cromo

\$ 1.544.00

Gancho doble.



Dimensiones:
vista frontal

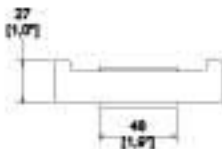

Dimensiones:
vista cenital

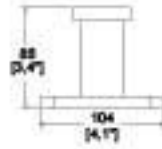

Acabado,



CR



VÉRTIKA CROMO

VÉRTIKA

16107

Cromo

\$ 2.574.00

Portacepillos.



Dimensiones:
vista cenital

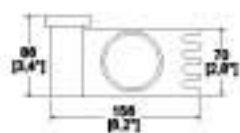

Dimensiones:
vista lateral

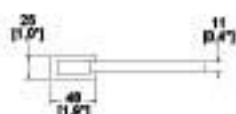

Acabado.



CR

VÉRTIKA

16108

Cromo

\$ 2.574.00

Jabonera.



Dimensiones:
vista cenital

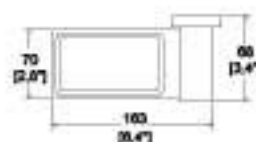

Dimensiones:
vista lateral

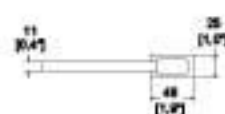

Acabado.



CR



VÉRTIKA

16109

Cromo

\$ 2.445.00

Toallero sencillo.



Dimensiones:
vista cenital

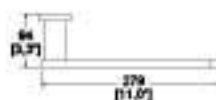

Dimensiones:
vista lateral



Acabado.



CR

TUBULAR

TUB-05

Cromo

\$ 2,224.00



Toallero de barra.



Dimensiones
vista cenital

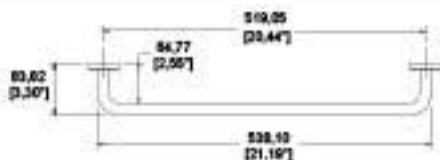

Dimensiones:
vista frontal



Acabado,



CR

TUBULAR

TUB-06

Cromo

\$ 743.00



Gancho sencillo.



Dimensiones
vista frontal



Dimensiones:
vista lateral

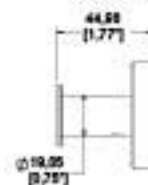

Acabado,



CR

TUBULAR

TUB-09

Cromo

\$ 1,099.00



Toallero sencillo.



Dimensiones:
vista frontal



Dimensiones:
vista cenital

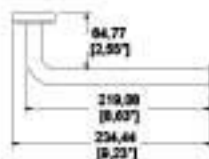

Acabado,



CR

TUBULAR

TUB-10

Cromo

\$ 4,457.00



Portatoallas múltiple.



Dimensiones:
vista cenital

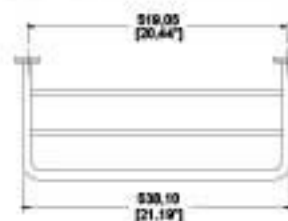

Dimensiones:
vista frontal



Acabado,



CR

TUBULAR CROMO

TUBULAR

TUB-17

Cromo

\$ 1.527.00

Portapapel sencillo.



Dimensiones:
vista frontal

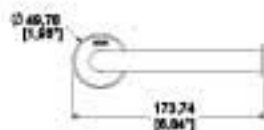

Dimensiones:
vista cenital

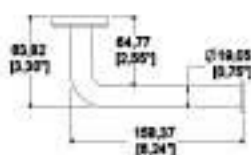

Acabado.



CR

TUBULAR ÉBANO

TUBULAR

TUB-05-EB

Ébano

\$ 2.558.00

Toallero de barra.



Dimensiones:
vista cenital

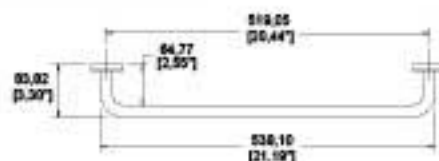

Dimensiones:
vista frontal



Acabado.



EB

TUBULAR

TUB-35

Cromo

\$ 2.290.00

Portapapel con soporte
de apoyo tipo barra
de seguridad.



Dimensiones:
vista frontal

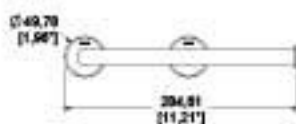

Dimensiones:
vista cenital

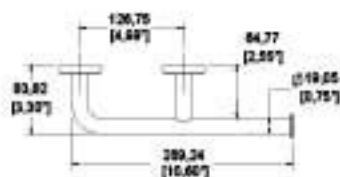

Acabado.



CR

TUBULAR

TUB-06-EB

Ébano

\$ 855.00

Gancho sencillo.



Dimensiones:
vista frontal



Dimensiones:
vista lateral

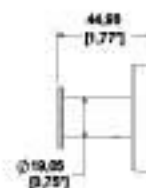

Acabado.



EB

TUBULAR
TUB-09-EB
Ébano

\$ 1,265.00

Toallero sencillo.



Dimensiones:
vista frontal

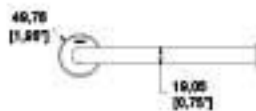

Dimensiones:
vista cenital

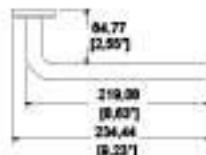

Acabado,



EB

TUBULAR
TUB-10-EB
Ébano

\$ 5,126.00

Portatoallas múltiple.



Dimensiones:
vista cenital



Dimensiones:
vista frontal



Acabado,



EB

TUBULAR
TUB-17-EB
Ébano

\$ 1,755.00

Portapapel sencillo.



Dimensiones:
vista frontal



Dimensiones:
vista cenital

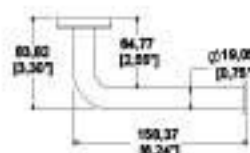

Acabado,



EB

TUBULAR
TUB-35-EB
Ébano

\$ 2,633.00

Portapapel con soporte
de apoyo tipo barra
de seguridad.



Dimensiones:
vista frontal

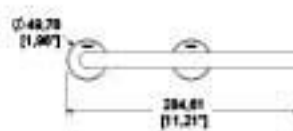

Dimensiones:
vista cenital

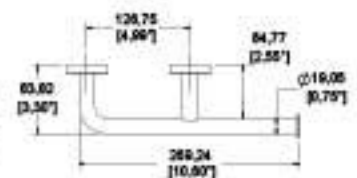

Acabado,



EB

JABONERAS Y REPISAS DE REJILLAS

REJ-01

Cromo

\$ 1.976.00

Jabonera de rejilla rectangular.



Dimensiones:
vista frontal



Dimensiones:
vista lateral

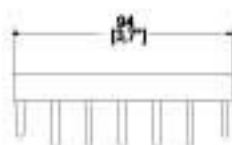

Acabado.



REJ-02

Cromo

\$ 2.399.00

Repisa de rejilla esquinera.



Dimensiones:
vista cenital



Dimensiones:
vista lateral



Acabado.



REJ-03

Cromo

\$ 5.767.00

Repisa de rejilla semicircular doble.



Dimensiones:
vista frontal

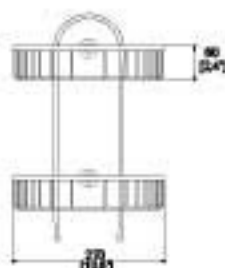

Dimensiones:
vista lateral

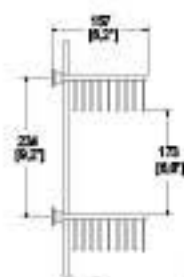

Acabado.



REJ-04

Cromo

\$ 7.168.00

Repisa de rejilla rectangular doble.



Dimensiones:
vista frontal

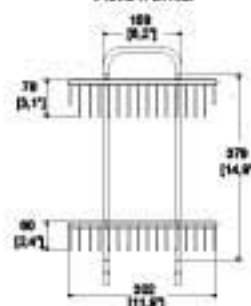

Dimensiones:
vista lateral



Acabado.



ÍNDICE ALFANUMÉRICO

MODELO	DESCRIPCIÓN	PRECIO	PÁGINA
E-305	Gourmet. Monomando para fregadero profesional con resorte	\$ 15,377.00	111
E-306	Palma. Monomando para fregadero cabezal retráctil	\$ 13,260.00	112
E-307	Curvo. Monomando para fregadero cabezal retráctil magnético	\$ 12,384.00	113
E-308	Gourmet Twin. Monomando para fregadero profesional doble	\$ 17,235.00	114
E-309	Doria. Monomando para fregadero con dos tipos de chorro	\$ 7,889.00	115
E-310	Doria. Monomando para fregadero sencillo de chorro fijo	\$ 6,978.00	116
E-310-EB	Doria. Monomando para fregadero sencillo de chorro fijo	\$ 8,024.00	116
E-312	Adara. Monomando para fregadero, cabezal retráctil	\$ 9,452.00	117
E-32	Nuva. Monomando para fregadero	\$ 7,369.00	108
E-32-EB	Nuva. Monomando para fregadero	\$ 8,474.00	108
E-34	Novus. Monomando para fregadero	\$ 5,431.00	109
E-39	Ergo. Monomando para fregadero con cabezal retráctil	\$ 10,419.00	109
E-40	Ensamble triple de empotrar para regadera y tina	\$ 3,468.00	143
E-40-AQ	Ensamble triple de empotrar para regadera o tina	\$ 3,063.00	143
E-40-II	Ensamble triple de empotrar para regadera y tina	\$ 3,468.00	143
E-45	Novus. Monomando para regadera o tina	\$ 4,163.00	146
E-46	Nuva. Monomando para regadera o tina	\$ 5,481.00	148
E-47	Nuva. Monomando para regadera, tina o regadera manual	\$ 5,750.00	148
E-48	Kúbica. Monomando para regadera o tina	\$ 6,647.00	152
E-49	Kúbica. Monomando para regadera, tina o regadera manual	\$ 7,542.00	152
E-50	Ensamble triple de empotrar para regadera y tina	\$ 2,450.00	144
E-50-AQ	Ensamble triple de empotrar para regadera o tina	\$ 2,022.00	144
E-50-II	Ensamble triple de empotrar para regadera o tina	\$ 2,450.00	144
E-59	Explora. Monomando para regadera o tina	\$ 4,081.00	146
E-60	Juego de ensamblajes individuales de empotrar para regadera	\$ 1,390.00	144
E-60-AQ	Juego de ensamblajes individuales de empotrar para regadera	\$ 1,045.00	144
E-60-II	Juego de ensamblajes individuales de empotrar para regadera	\$ 1,390.00	144
E-61	Juego de ensamblajes individuales de empotrar para regadera	\$ 1,390.00	145
E-61-AQ	Juego de ensamblajes individuales de empotrar para regadera	\$ 1,045.00	145
E-61-II	Juego de ensamblajes individuales de empotrar para regadera	\$ 1,390.00	145
E-72	Mantiss. Monomando para regadera o tina	\$ 4,163.00	146
E-77	Aqua. Monomando para regadera o tina	\$ 4,188.00	146
E-700	Vértika. Monomando para regadera o tina	\$ 5,694.00	152
E-701	Vértika. Monomando para regadera, tina o regadera manual	\$ 6,267.00	152
E-702	Premier. Monomando para regadera o tina	\$ 5,258.00	150
E-702-EB	Premier. Monomando para regadera o tina	\$ 6,051.00	150
E-703	Premier. Monomando para regadera, tina o regadera manual	\$ 5,960.00	151
E-705	Explora. Monomando para regadera, tina o regadera manual	\$ 4,779.00	147
E-708	Century. Monomando para regadera o tina	\$ 3,978.00	147
E-709	Century. Monomando para regadera, tina o regadera manual	\$ 4,615.00	147
E-710	Squadra. Monomando para regadera o tina	\$ 4,208.00	155
E-710-EB	Squadra. Monomando para regadera o tina	\$ 4,839.00	155
E-711	Squadra. Monomando para regadera, tina o regadera manual	\$ 5,067.00	155
E-712	Máxima. Monomando para regadera o tina	\$ 4,182.00	156
E-712-EB	Máxima. Monomando para regadera o tina	\$ 4,809.00	156
E-713	Máxima. Monomando para regadera, tina o regadera manual	\$ 5,067.00	156
E-713-EB	Máxima. Monomando para regadera, tina o regadera manual	\$ 5,827.00	156
E-714	Nautilia. Monomando para regadera o tina	\$ 5,381.00	151
E-717-EB	Indus. Monomando para regadera o tina	\$ 5,335.00	148
E-718-EB	Indus. Monomando para regadera o tina	\$ 6,030.00	148
E-791	Century. Monomando para regadera, tina o regadera manual	\$ 5,986.00	147
E-793	Squadra. Monomando para regadera, tina o regadera manual	\$ 6,466.00	155

REJ-05

Cromo

\$7.981.00

Repisa de rejilla
esquinera doble.



Dimensiones:
vista cenital

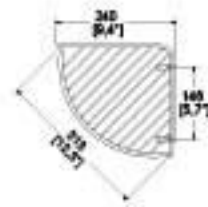

Dimensiones:
vista lateral

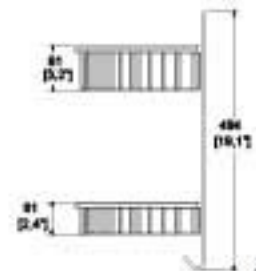

Acabado,

CR



ESPEJOS DE AUMENTO

ES-001

Cromo

\$ 5.699.00

Espejo de doble vista giratorio con aumento de 3x en una cara.

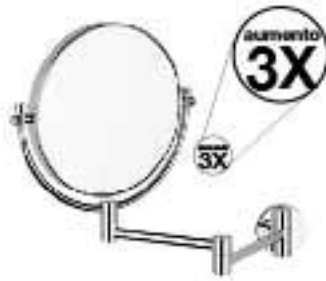

Dimensiones:
vista frontal

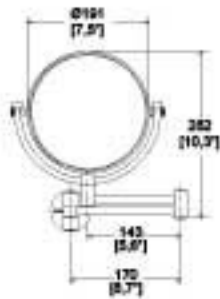

Dimensiones:
vista lateral

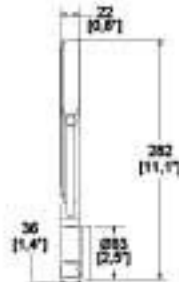

Acabado.

CR

ES-003

Cromo

\$ 7.988.00

Espejo retráctil, aumento de 5x, con luz led, encendido y apagado con botón tipo touch.



Dimensiones:
vista frontal

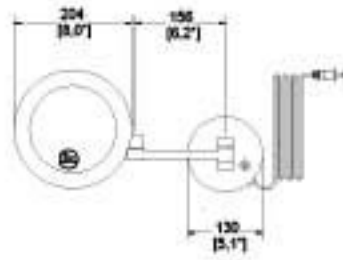

Dimensiones:
vista lateral

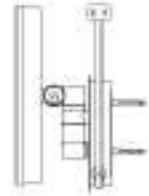

Acabado.

CR



BR-470

Cromo

\$ 3.099.00

Barra de seguridad residencial antiderripante.

ACCESORIO
INSTITUCIONAL



Dimensiones:
vista frontal

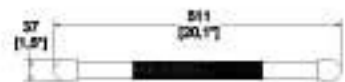

Dimensiones:
vista cenital

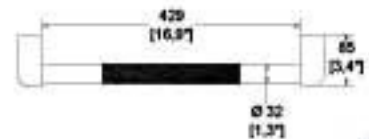

Acabado.

CR

PORTAPAPEL CON REPISA PARA CELULAR

17

Cromo

\$ 1.486.00



Dimensiones:
vista frontal



Dimensiones:
vista cenital

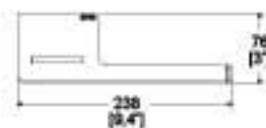

Acabado.



CR



ACABADOS



CR
Cromo



EB
Ébano



AI
Acero
Inoxidable



NI
Niquel

COCINA



Mezcladoras.



Mezcladoras con
manguera retráctil.



Monomandos.



Complementos para cocina.



Visite nuestra página web para consultar y descargar
fichas técnicas e instructivos de instalación.
haivez.com    

MEZCLADORAS Y MONOMANDOS PARA FREGADERO



CUELLO GIRATORIO



HELVEX

Garantía de Calidad



Garantía Helvex en acabado cromo de 10 años
y resto de acabados 2 años.

MEZCLADORAS PARA COCINA

ALBATROS

HM-37

Cromo

\$ 5,215.00

Mezcladora para fregadero.



Dimensiones:
vista frontal

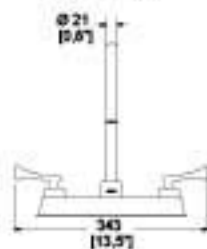

Dimensiones:
vista lateral

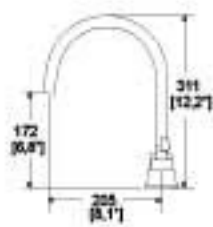

Cuello giratorio.
Presión mínima requerida 0.25 kg/cm².



CR

FLAMINGO

HM-38

Cromo

\$ 5,215.00

Mezcladora para fregadero.



Dimensiones:
vista frontal

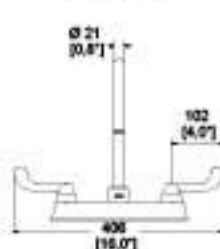

Dimensiones:
vista lateral

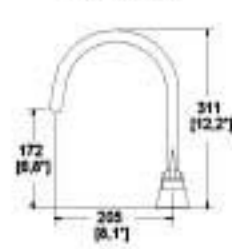

Cuello giratorio.
Presión mínima requerida 0.25 kg/cm².



CR



TRITÓN

ME-302

Cromo

\$ 5,167.00

Mezcladora para fregadero.



Dimensiones:
vista frontal

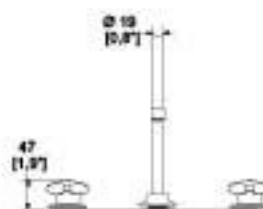

Dimensiones:
vista lateral

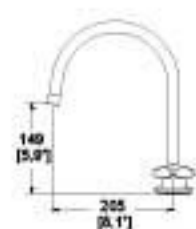

Cuello giratorio.
Presión mínima requerida 0.25 kg/cm².



CR

MEZCLADORAS PARA COCINA

PREMIER

ME-303

Cromo

\$ 9.855.00

Mezcladora para fregadero con cabezal retráctil magnético y dos tipos de chorro.



SISTEMA ANTICALCAREO



Dimensiones vista frontal

Dimensiones vista lateral

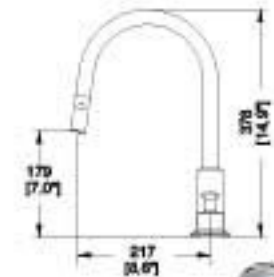
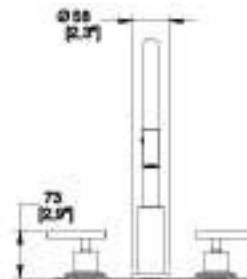

Cuello giratorio.
Presión mínima requerida 1.0 kg/cm².
Longitud de la manguera 150 cm.



CR

TIPOS DE CHORRO



Chorro 1



Chorro 2



Cabezal retráctil



SISTEMA ANTICALCAREO

MEZCLADORAS PARA COCINA

PREMIER

ME-304

Cromo

\$ 8.953.00

Mezcladora para fregadero.
Cabezal movable 360°
y dos tipos de chorro.



Dimensiones:
vista frontal

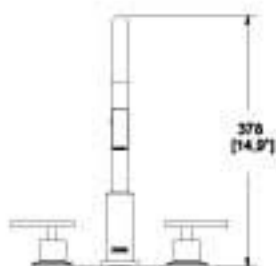

Dimensiones:
vista lateral

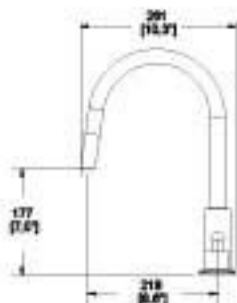

Cuello giratorio.
Presión mínima requerida 1.0 kg/cm².

CR

TIPOS DE CHORRO



Chorro 1

Chorro 2



SISTEMA
ANTICALCÁREO



ÍNDICE ALFANUMÉRICO

MODELO	DESCRIPCIÓN	PRECIO	PÁGINA
E-907	Explora. Monomando de lavabo	\$ 5,561.00	42
E907-1.9 <small>◀ ECOUSDA</small>	Explora. Monomando de lavabo	\$ 5,561.00	42
E-907-CE	Explora. Monomando de lavabo	\$ 5,561.00	42
E907-CE-6 <small>◀ ECOUSDA</small>	Explora. Monomando de lavabo	\$ 5,561.00	42
E-908	Explora. Monomando de lavabo	\$ 5,158.00	42
E-908-CE	Explora. Monomando de lavabo	\$ 5,158.00	42
E-916	Konos. Monomando de lavabo	\$ 7,030.00	29
E-917	Clásica. Monomando de lavabo	\$ 6,043.00	29
E-920	Álika. Monomando de lavabo	\$ 8,447.00	30
E-921	Álika alto. Monomando de lavabo	\$ 10,586.00	30
E-922	Bamboo. Monomando de lavabo	\$ 8,038.00	31
E-922-B	Bamboo. Monomando de lavabo	\$ 9,243.00	31
E-922-EB	Bamboo. Monomando de lavabo	\$ 9,243.00	31
E-923	Bamboo alto. Monomando de lavabo	\$ 9,387.00	32
E-923-B	Bamboo alto. Monomando de lavabo	\$ 10,796.00	32
E-923-EB	Bamboo alto. Monomando de lavabo	\$ 10,796.00	32
E-924	Nautilia. Monomando de lavabo	\$ 8,447.00	41
E-925	Nautilia alto. Monomando de lavabo	\$ 9,852.00	41
E-928	Century. Monomando de lavabo	\$ 5,269.00	29
E928-1.9 <small>◀ ECOUSDA</small>	Century. Monomando de lavabo	\$ 5,269.00	29
E-929	Squadra. Monomando de lavabo	\$ 5,436.00	40
E929-1.9 <small>◀ ECOUSDA</small>	Squadra. Monomando de lavabo	\$ 5,436.00	40
E-930	Novara. Monomando de lavabo	\$ 7,220.00	40
E-937	Squadra alto. Monomando de lavabo	\$ 7,520.00	40
E-939	Land. Monomando de lavabo	\$ 6,043.00	45
E-939-EB <small>◀ NUEVO</small>	Land. Monomando de lavabo	\$ 6,949.00	45
E-940	Alba. Monomando de lavabo	\$ 8,038.00	46
E-941	Premier II. Monomando de lavabo	\$ 6,518.00	39
E-941-EB	Premier II. Monomando de lavabo	\$ 7,497.00	39
E-943	Century alto. Monomando de lavabo	\$ 6,898.00	29
E-948	Scala. Monomando de lavabo	\$ 7,670.00	34
E-948-EB	Scala. Monomando de lavabo	\$ 8,821.00	34
E-949	Scala alto. Monomando de lavabo	\$ 8,922.00	34
E-949-EB	Scala alto. Monomando de lavabo	\$ 10,259.00	34
E-950-EB	Indus. Monomando de lavabo	\$ 9,243.00	35
E-951-EB	Indus alto. Monomando de lavabo	\$ 10,796.00	35
EP-3003	Nuva. Monomando de lavabo a pared	\$ 10,343.00	50
EP-3005	Kúbica. Monomando de lavabo a pared	\$ 12,308.00	50
EP-3007	Vértika. Monomando de lavabo a pared	\$ 11,015.00	50
EP-3007-EB <small>◀ NUEVO</small>	Vértika. Monomando de lavabo a pared	\$ 12,667.00	50
EP-905	Vértika. Monomando de lavabo	\$ 9,308.00	35
EP-909	Premier. Monomando de lavabo	\$ 7,099.00	37
EP-909-EB	Premier. Monomando de lavabo	\$ 8,162.00	37
EP-932	Máxima mediano. Monomando de lavabo	\$ 7,304.00	44
EP-932-EB <small>◀ NUEVO</small>	Máxima mediano. Monomando de lavabo	\$ 8,400.00	44
EP-933	Máxima alto. Monomando de lavabo	\$ 8,652.00	44
EP-933-EB <small>◀ NUEVO</small>	Máxima alto. Monomando de lavabo	\$ 9,950.00	44
EP-938	Premier alto. Monomando de lavabo	\$ 9,122.00	38
EP-938-EB	Premier alto. Monomando de lavabo	\$ 10,489.00	38
EP-94	Kúbica. Monomando de lavabo	\$ 10,161.00	40
EP-945	Nuva mediano. Monomando de lavabo	\$ 11,655.00	36
EP-947	Nuva alto. Monomando de lavabo	\$ 11,964.00	36

NUVA

E-32

Cromo

\$ 7,369.00

Monomando para fregadero.



Salida giratoria.
Presión mínima requerida 0.25 kg/cm².



CR

NUVA

E-32-EB

Ébano

\$ 8,474.00

Monomando para fregadero.



Salida giratoria.
Presión mínima requerida 0.25 kg/cm².



EB

Dimensiones:
vista frontal

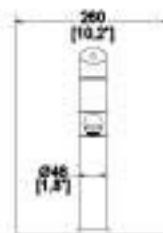

Dimensiones:
vista lateral



MONOMANDOS PARA COCINA

NOVUS

E-34

Cromo

\$ 5.431.00

Monomando para fregadero.



Dimensiones:
vista frontal

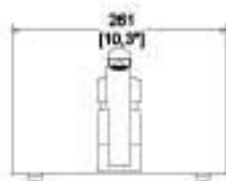

Dimensiones:
vista lateral

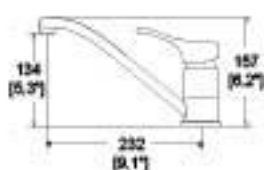

Cuello giratorio.
Presión mínima requerida 0.25 kg/cm².



CR

ERGO

E-39

Cromo

\$ 10.419.00

Monomando para fregadero con cabezal retráctil y dos tipos de chorro.



SISTEMA
ANTICALCÁREO



Dimensiones:
vista frontal

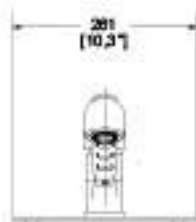

Dimensiones:
vista lateral

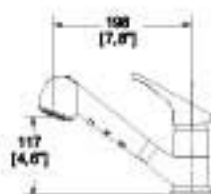

Cuello giratorio.
Presión mínima requerida 0.60 kg/cm².
Longitud de la manguera 148 cm.



CR



ELITE

E-300

Cromo

\$ 5,573.00

Monomando para fregadero.



CR

Cuello giratorio.
Presión mínima requerida 0.25 kg/cm².

ELITE

E-300-EB

Ébano

\$ 6,409.00

Monomando para fregadero.



EB

Cuello giratorio.
Presión mínima requerida 0.25 kg/cm².



Dimensiones:
vista frontal

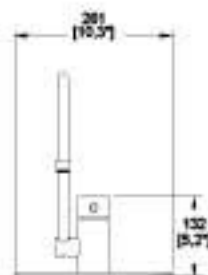

Dimensiones:
vista lateral

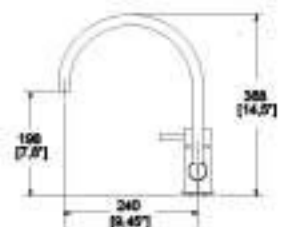

MONOMANDOS PARA COCINA

GOURMET

E-305

Cromo

\$ 15,377.00

Monomando profesional para fregadero, con resorte y dos tipos de chorro.



SISTEMA ANTICALCÁREO



Dimensiones:
vista frontal



Dimensiones:
vista lateral

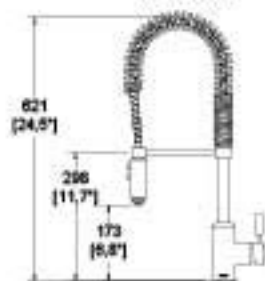

Cuello giratorio.
Presión mínima requerida 1.00 kg/cm².
Longitud de la manguera 61 cm.



CR

TIPOS DE CHORRO



SISTEMA ANTICALCÁREO

PALMA

E-306

Cromo

\$ 13,260.00

Monomando para fregadero cabezal retráctil, con dos tipos de chorro.



SISTEMA ANTICALCÁREO



Dimensiones:
vista frontal



Dimensiones:
vista lateral

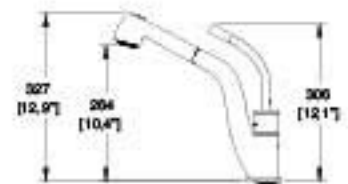

Cuello giratorio.
Presión mínima requerida 0.60 kg/cm².
Longitud de la manguera 148 cm.



CR

TIPOS DE CHORRO



SISTEMA ANTICALCÁREO

MONOMANDOS PARA COCINA

CURVO

E-307

Cromo

\$ 12.384.00

Monomando para fregadero. Cabezal retráctil magnético con dos tipos de chorro.



SISTEMA ANTICALCAREO



Dimensiones:
vista frontal

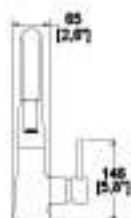

Dimensiones:
vista lateral



Cuello giratorio.
Presión mínima requerida 1.00 kg/cm².
Longitud de la manguera 150 cm.



CR

TIPOS DE CHORRO



GOURMET TWIN

E-308
Cromo

\$ 17.235.00

Monomando profesional doble para fregadero, cabezal con dos tipos de chorro.



SISTEMA ANTICALCÁREO



Dimensiones:
vista frontal



Dimensiones:
vista lateral

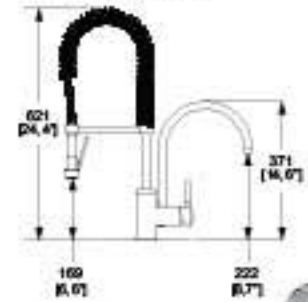

Cuello giratorio.
Presión mínima requerida 1.00 kg/cm².
Longitud de la manguera 61 cm.



CR

TIPOS DE CHORRO



MONOMANDOS PARA COCINA

DORIA

E-309

Cromo

\$7.889.00

Monomando para fregadero con dos tipos de chorro, con cabezal movable 360°.

Dimensiones vista frontal

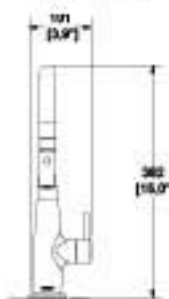

Dimensiones vista lateral



Incluye kit cubretaladros.
Cuello giratorio.
Presión mínima requerida 1.0 kg/cm².

CR



DORIA

E-310

Cromo

\$ 6,978.00

Monomando para fregadero sencillo de chorro fijo



Incluye kit cubretaladros.
Cuello giratorio.
Presión mínima requerida 0.60 kg/cm².



CR

DORIA

E-310-EB

Ébano

\$ 8,024.00

Monomando para fregadero sencillo de chorro fijo.



Incluye kit cubretaladros.
Cuello giratorio.
Presión mínima requerida 0.60 kg/cm².



EB

Dimensiones:
vista frontal



Dimensiones:
vista lateral

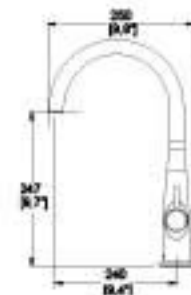

ADARA

E-312

Cromo

\$ 9.452.00

Monomando para fregadero, cabezal retráctil con dos tipos de chorro.



Dimensiones:
vista frontal



Dimensiones:
vista lateral

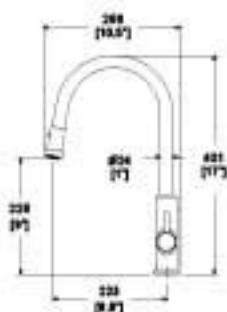

Incluye kit cubretaladros.
Cuello giratorio.
Presión mínima requerida 1.0 kg/cm².

CR



ÍNDICE ALFANUMÉRICO

MODELO	DESCRIPCIÓN	PRECIO	PÁGINA
EP-99	Nuva. Monomando de lavabo	\$ 9,674.00	36
EP3003-19	Nuva. Monomando de lavabo a pared	\$ 10,343.00	50
EP99-19	Nuva. Monomando de lavabo	\$ 9,674.00	36
ES-001	Espejo de doble vista giratorio con aumento de 3x	\$ 5,699.00	101
ES-003	Espejo retráctil, aumento de 5x, con luz led	\$ 7,988.00	101
FB-110-38	Flujómetro de sensor electrónico de baterías para taza flux, 6 L por descarga	\$ 20,435.00	214
FB-110-38-3.5	Flujómetro de sensor electrónico de baterías para tazas flux, 3.5 L por descarga	\$ 20,435.00	214
FB-110-WC-4.8	Flujómetro de sensor electrónico de baterías para taza flux, 4.8 L por descarga	\$ 20,435.00	214
FB-185-19	Flujómetro de sensor electrónico de baterías para mingitorio, 3 L por descarga	\$ 20,435.00	215
FB-185-19-0.5	Flujómetro de sensor electrónico de baterías para mingitorio, 0.5 L por descarga	\$ 20,435.00	215
FB-185-19-1	Flujómetro de sensor electrónico de baterías para mingitorio, 1 L por descarga	\$ 20,435.00	215
FC-110-38-3.5	Flujómetro de sensor electrónico para taza flux, 3.5 L por descarga	\$ 20,435.00	212
FC-110-WC-4.8	Flujómetro de sensor electrónico de corriente para taza flux, 4.8 L por descarga	\$ 20,435.00	212
FC-185-19	Flujómetro de sensor electrónico para mingitorio, 3 L por descarga	\$ 20,435.00	213
FC-185-19-0.5	Flujómetro de sensor electrónico de corriente para mingitorio, 0.5 L por descarga	\$ 20,435.00	213
FC-185-19-1	Flujómetro de sensor electrónico para mingitorio, 1 L por descarga	\$ 20,435.00	213
FERRY 1-1	Paquete institucional con flujómetro de manija y mingitorio	\$ 9,112.00	259
FERRY FB-1	Paquete institucional con flujómetro de sensor de baterías y mingitorio	\$ 14,746.00	260
FERRY FC-1	Paquete institucional con flujómetro de sensor de corriente y mingitorio	\$ 14,746.00	260
H-100	Regadera de chorro fijo	\$ 2,365.00	121
H100-6	Regadera de chorro fijo	\$ 2,365.00	121
H-102	Konos. Regadera de chorro fijo	\$ 1,096.00	121
H-105	Regadera de chorro fijo	\$ 3,771.00	121
H-13341G	Mezcladora de hospital 8" a 12" con cuello de ganso giratorio	\$ 7,225.00	185
H13341G-19	Mezcladora de hospital 8" a 12" con cuello de ganso giratorio	\$ 7,225.00	185
H-200	Óptima. Regadera de chorro fijo	\$ 1,427.00	121
H200-6	Óptima. Regadera de chorro fijo	\$ 1,427.00	121
H-201	Explora. Regadera de chorro fijo	\$ 1,656.00	122
H201-6	Explora. Regadera de chorro fijo	\$ 1,656.00	122
H-201-B	Explora. Regadera de chorro fijo	\$ 1,904.00	122
H-201-EB	Explora. Regadera de chorro fijo	\$ 1,904.00	122
H-202	Iguazú. Regadera de chorro vigorizante	\$ 1,578.00	123
H-202-EB	Iguazú. Regadera de chorro vigorizante	\$ 1,815.00	123
H-3002	Kúbica. Regadera de chorro fijo, plato ancho	\$ 10,785.00	128
H-3003	Regadera de chorro fijo con sistema anticalcáreo plato ancho	\$ 3,406.00	128
H3003-8	Regadera de chorro fijo con sistema anticalcáreo plato ancho	\$ 3,406.00	128
H-3004	Regadera de chorro fijo con sistema anticalcáreo plato ancho	\$ 3,406.00	128
H-3005	Premier. Regadera de chorro fijo con plato ancho	\$ 5,723.00	130
H3005-6	Premier. Regadera de chorro fijo con plato ancho	\$ 5,723.00	130
H-3006	Kúbica. Regadera de chorro fijo con plato ancho	\$ 7,658.00	131
H3006-6	Kúbica. Regadera de chorro fijo con plato ancho	\$ 7,658.00	131
H-3007	Regadera de chorro fijo con plato ancho	\$ 10,520.00	128
H-3008	Regadera redonda, plato ancho. Ultraplana de chorro fijo	\$ 9,373.00	132
H-3009	Regadera cuadrada, plato ancho. Ultraplana de chorro fijo	\$ 9,605.00	132
H-3010	Regadera redonda, plato ancho. Ultraplana de chorro fijo	\$ 9,405.00	133
H-3011	Regadera cuadrada, plato ancho. Ultraplana de chorro fijo	\$ 9,637.00	133
H-3013	Regadera cuadrada, plato ancho. Ultraplana de chorro fijo	\$ 14,701.00	133
H-3300	Regadera multichorro. Con botón de cambios en el plato	\$ 2,298.00	134
H-3301-C/G	Regadera multichorro. Con palanca de cambios en el plato	\$ 2,824.00	134
H-3302	Regadera redonda multichorro de plato ancho	\$ 3,976.00	135
H-3302-C/B	Regadera redonda multichorro de plato ancho	\$ 3,976.00	135
H-3303	Regadera cuadrada multichorro de plato ancho	\$ 3,976.00	135

CONTRACANASTA PARA FREGADERO

H-8801

Acero inoxidable

\$ 2.413.00

Contracanasta para fregadero.



Dimensiones:
vista frontal

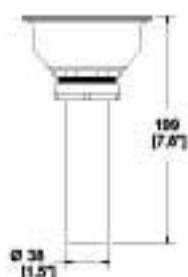

Dimensiones:
vista carinal



Acabado.



AI

H-8802

Acero inoxidable

\$ 1.476.00

Contracanasta para fregadero con canastilla removible.



Dimensiones:
vista frontal

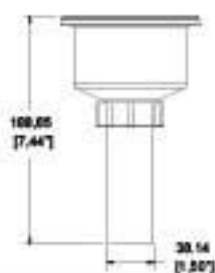

Dimensiones:
vista carinal

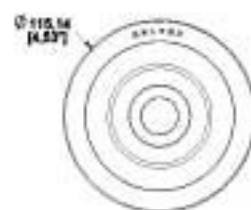

Cuerpo de polipropileno.
Tapa y canastilla de acero inoxidable.



AI

COMPLEMENTOS PARA COCINA

TV-012

Cromo

\$ 807.00

Válvula de paso roscable.



Dimensiones:
vista frontal

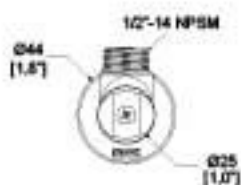

Dimensiones:
vista lateral

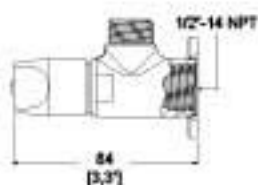

100% latón.

Para instalarse en lavabo, fregadero y WC.

CR

TV-030

Cromo

\$ 2,481.00

Césped para fregadero con registro.



Dimensiones
vista frontal

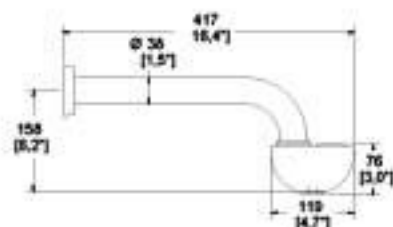

Dimensiones
vista cenital

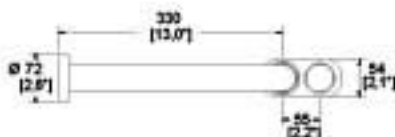

Acabado.

CR

TV-031

Níquel

\$ 2,220.00

Conexión para céspol.
Tarja doble.



Dimensiones
vista frontal

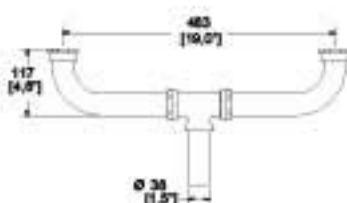

Dimensiones:
vista lateral



Acabado.

NI

ACABADOS



EB
Ébano



CR
Cromo



B
Polar

REGADERAS



Chorro fijo.



Chorro regulable.



Tecnología Aireavex.



Switch.



Plato ancho
y gran formato.



Regaderas de altura
deslizable.

Tecnologías innovadoras y certificaciones:



Tecnología que proporciona una sensación de abundancia a través de un chorro burbujeante. Aumenta un 20% el chorro de agua y se ahorra un 10% de agua.







Distintivo de la CONAGUA para productos que ahorran agua.



Premio EcoCihac a algunos de nuestros productos por su tecnología ahorradora de agua.



Todas nuestras regaderas cumplen con la Norma Oficial Mexicana NOM-008-CONAGUA-1998 "Regaderas Empleadas en el Aseo Corporal-Especificaciones y Métodos de Prueba".

Visite nuestra página web para consultar y descargar fichas técnicas e instructivos de instalación.
helvex.com    



REGADERAS

DIVERSIDAD DE ESTILOS: CHORRO FIJO, MULTICHORRO, GRAN FORMATO, PLATO ANCHO Y MANUALES.

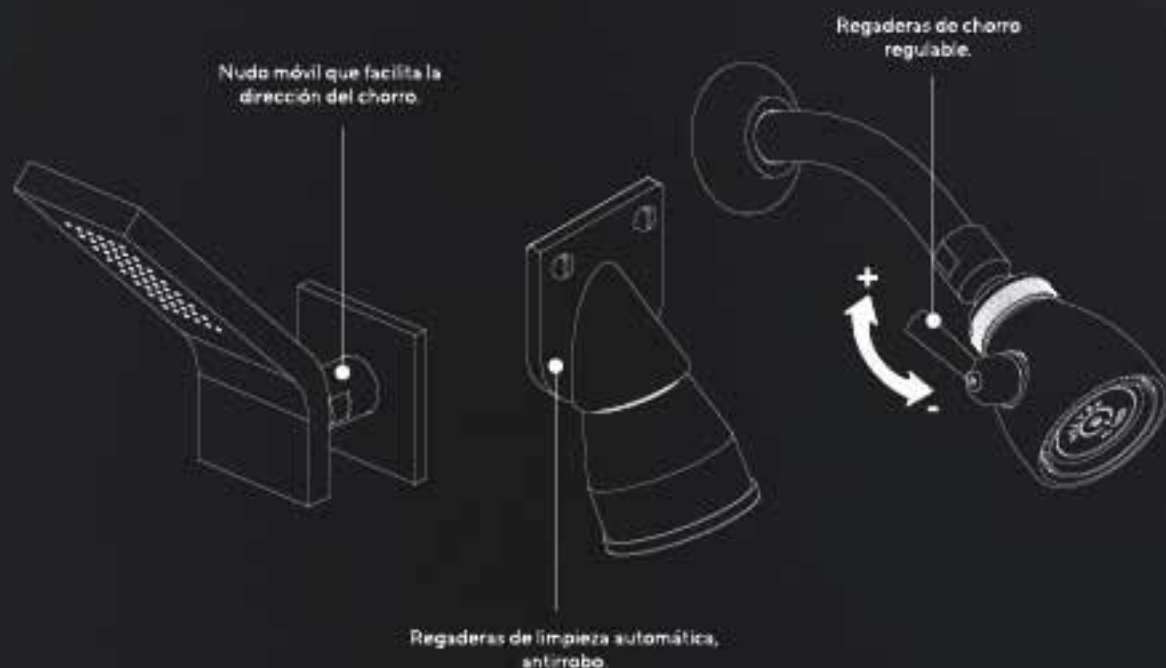

Garantía Helvex en acabado cromo de 10 años y resto de acabados 2 años.



ECOLVEX

Regaderas con uso eficiente de agua.



Tecnología que proporciona una sensación de abundancia a través de un chorro burbujeante.



Fácil limpieza, gracias a su sistema anticálcico.

HELVEX

Garantía de Calidad

REGADERAS DE CHORRO FIJO

H-100

Cromo

\$ 2,365.00

Regadera de chorro fijo.



Dimensiones
vista inferior

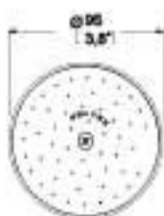

Dimensiones
vista lateral

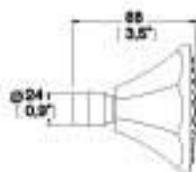

Presión mínima requerida 0.20 kg/cm².
Consumo máximo de agua: 10 L/min.

CR



NUDO MÓVIL



KONOS

H-102

Cromo

\$ 1,096.00

Regadera de chorro fijo.

Dimensiones:
vista inferior



Dimensiones:
vista lateral

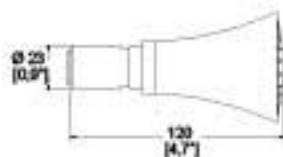

Presión mínima requerida 0.20 kg/cm².
Consumo máximo de agua: 10 L/min.

CR



NUDO MÓVIL



H-105

Cromo

\$ 3,771.00

Regadera de chorro fijo.

Dimensiones
vista inferior



Dimensiones
vista lateral

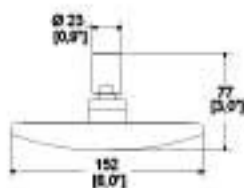

Presión mínima requerida 0.20 kg/cm².
Consumo máximo de agua: 10 L/min.

CR



NUDO MÓVIL



ÓPTIMA

H-200

Cromo

\$ 1,427.00

Regadera de chorro fijo.
Incluye brazo y chapetón.

Dimensiones:
vista frontal



Dimensiones:
vista lateral

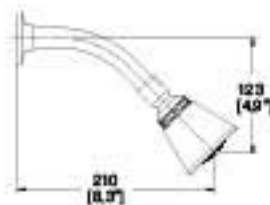

Presión mínima requerida 0.20 kg/cm².
Consumo máximo de agua: 10 L/min.

CR



NUDO MÓVIL



SISTEMA
ANTICALCÁREO



CR



Dimensiones:
vista frontal



Dimensiones:
vista lateral

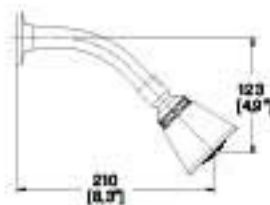

SISTEMA
ANTICALCÁREO



CR

NOM NOM-008-CONAGUA-1998

EXPLORA

H-201
Cromo

\$1,656.00

Regadera de chorro fijo.
Incluye brazo y chapetón.



Dimensiones:
vista frontal



Dimensiones:
vista lateral

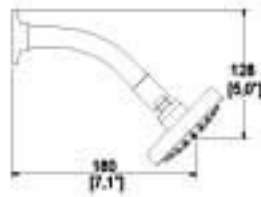

Presión mínima requerida 0.20 kg/cm².
Consumo máximo de agua: 10 L/min.



EXPLORA

H-201-EB
Ébano

\$1,904.00

Regadera de chorro fijo.
Incluye brazo y chapetón.



NUDO MÓVIL

Dimensiones:
vista frontal



Dimensiones:
vista lateral

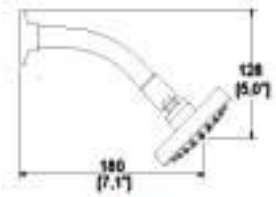

Presión mínima requerida 0.20 kg/cm².
Consumo máximo de agua: 10 L/min.



EXPLORA

H-201-B
Polar

\$1,904.00

Regadera de chorro fijo.
Incluye brazo y chapetón.

Dimensiones:
vista frontal



Dimensiones:
vista lateral

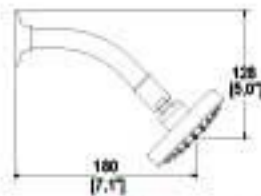

Presión mínima requerida 0.20 kg/cm².
Consumo máximo de agua: 10 L/min.



NOM NOM-008-CONAGUA-1998

REGADERAS DE CHORRO FIJO

IGUAZÚ

H-202

Cromo

\$ 1.578.00

Regadera de chorro vigorizante.
Incluye brazo y chapetón.



Dimensiones
vista frontal

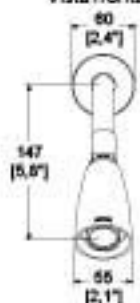

Dimensiones
vista lateral

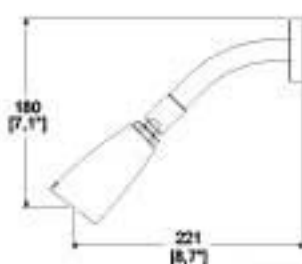

Presión mínima requerida 1.5 kg/cm².
Consumo máximo de agua: 9.5 L/min.

CR

IGUAZÚ

H-202-EB

Ébano

\$ 1.815.00

Regadera de chorro vigorizante.
Incluye brazo y chapetón.



Dimensiones
vista frontal

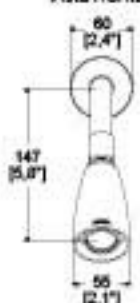

Dimensiones
vista lateral

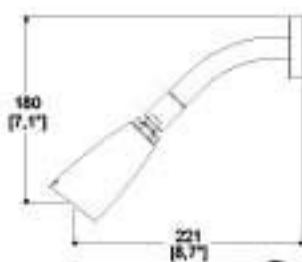

Presión mínima requerida 1.5 kg/cm².
Consumo máximo de agua: 9.5 L/min.

EB



REGADERAS DE CHORRO FIJO

H-500

Cromo

\$ 1,675.00

Modelo ahorrador

H500-6

H500-8

\$ 1,724.00



NUDO MÓVIL



Regadera de chorro fijo.

Dimensiones:
vista inferior



Dimensiones:
vista lateral

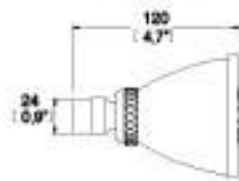

Presión mínima requerida 0.20 kg/cm².
Consumo máximo de agua: 10 L/min.



CR

H-600

Cromo

\$ 1,427.00

Regadera de chorro fijo.



NUDO MÓVIL



Dimensiones:
vista inferior

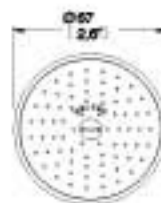

Dimensiones:
vista lateral

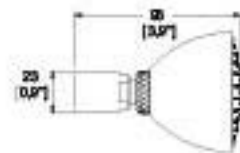

Presión mínima requerida 0.20 kg/cm².
Consumo máximo de agua: 10 L/min.



CR

NOM NOM-008-CONAGUA-1998

REGADERAS DE CHORRO FIJO

NUVA

H-900
Cromo

\$ 2,960.00



NUDO MÓVIL

Regadera de chorro fijo.
Incluye brazo y chapetón.



Dimensiones
vista frontal



Dimensiones
vista lateral

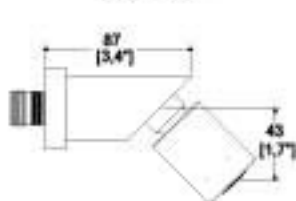

Presión mínima requerida
0.20 kg/cm².
Consumo máximo de agua:
10 L/min.



SISTEMA
ANTICALCÁREO



GRADO
ECOLÓGICO



CR

VÉRTIKA

H-904
Cromo

\$ 4,156.00



NUDO MÓVIL

Regadera de chorro fijo.
Incluye brazo y chapetón.



Dimensiones
vista inferior



Dimensiones
vista lateral

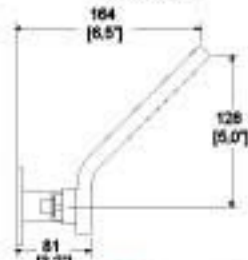

Presión mínima requerida 1.00 kg/cm².
Consumo máximo de agua: 10 L/min.



SISTEMA
ANTICALCÁREO



CR

NOM NOM-008-CONAGUA-1998

ÍNDICE ALFANUMÉRICO

MODELO	DESCRIPCIÓN	PRECIO	PÁGINA
H-3303-C/B	Regadera cuadrada multichorro de plato ancho	\$ 3,976.00	135
H-500	Regadera de chorro fijo	\$ 1,675.00	124
H500-6 < ECOLINE	Regadera de chorro fijo	\$ 1,724.00	124
H500-8 < ECOLINE	Regadera de chorro fijo	\$ 1,724.00	124
H-600	Regadera de chorro fijo	\$ 1,427.00	124
H-7190	Desagüe para tina con sistema de push	\$ 3,376.00	161
H-8801	Contra canasta para fregadero	\$ 2,413.00	118
H-8802 < NUEVO	Contra canasta para fregadero con canastilla removible	\$ 1,476.00	118
H-900 < ECOLINE	Nuva. Regadera de chorro fijo	\$ 2,960.00	125
H-904	Vértika. Regadera de chorro fijo	\$ 4,156.00	125
H1000-TR011	Regadera de chorro regulable	\$ 3,801.00	127
H3005-TR035-EB	Premier. Regadera de chorro fijo con plato ancho	\$ 8,437.00	130
H3006-TR035-EB	Kúbica. Regadera de chorro fijo con plato ancho	\$ 10,664.00	131
HM-14	Antares. Mezcladora de lavabo 4"	\$ 5,130.00	25
HM-17	Albatros. Mezcladora de lavabo 4"	\$ 4,956.00	25
HM-18	Antea. Mezcladora de lavabo 4"	\$ 4,894.00	25
HM-21	Ática. Mezcladora de lavabo 4"	\$ 5,130.00	25
HM-22	Acaya. Mezcladora de lavabo 4"	\$ 4,894.00	26
HM-37	Albatros. Mezcladora para fregadero	\$ 5,215.00	105
HM-38	Flamingo. Mezcladora para fregadero	\$ 5,215.00	105
HOT-105	Explora. Toallero de barra	\$ 2,433.00	82
HOT-105-45 < NUEVO	Explora. Toallero de barra de 45 cm	\$ 2,266.00	82
HOT-106	Explora. Gancho sencillo	\$ 821.00	82
HOT-107	Explora. Portacepillos	\$ 1,191.00	82
HOT-108	Explora. Jabonera	\$ 1,186.00	83
HOT-109	Explora. Toallero sencillo	\$ 1,618.00	83
HOT-117	Explora. Portapapel	\$ 1,559.00	83
IG-20	Interceptor de grasa con canastilla para sedimentos sólidos	\$ 20,701.00	180
IG-20-PTM	Interceptor de grasa de polietileno con tapa metálica	\$ 16,325.00	180
IG-40	Interceptor de grasa con canastilla para sedimentos sólidos	\$ 35,863.00	180
LUS-100	Lusitania. Monomando de lavabo	\$ 3,039.00	46
LUS-101	Lusitania alto. Monomando de lavabo	\$ 4,132.00	46
LUS-200	Lusitania. Monomando para regadera o tina	\$ 2,123.00	153
LV ALASKA < NUEVO	Lavabo de sobreponer sin rebosadero	\$ 3,695.00	244
LV ANNI < NUEVO	Lavabo de una perforación de sobreponer con rebosadero	\$ 2,091.00	244
LV CASSINI	Lavabo de sobreponer sin rebosadero	\$ 1,936.00	246
LV CASSINI M	Lavabo de sobreponer sin rebosadero. Color marfil	\$ 1,936.00	246
LV CLAP	Lavabo de sobreponer sin rebosadero	\$ 2,103.00	246
LV ELIPSIS < NUEVO	Lavabo de sobrecubierta sin rebosadero	\$ 1,403.00	250
LV FUTURA1	Lavabo de una perforación de sobreponer con rebosadero	\$ 3,695.00	247
LV FUTURA1 M	Lavabo de una perforación de sobreponer con rebosadero. Color marfil	\$ 3,695.00	247
LV LUCERNA1	Lavabo de una perforación de sobreponer con rebosadero	\$ 3,695.00	247
LV LUCERNA1 M	Lavabo de una perforación de sobreponer con rebosadero. Color marfil	\$ 3,695.00	247
LV LUCERNA3	Lavabo de tres perforaciones de sobreponer con rebosadero	\$ 3,695.00	248
LV LUCERNA3 M	Lavabo de tres perforaciones de sobreponer con rebosadero. Color marfil	\$ 3,695.00	248
LV LUGANO	Lavabo de bajocubierta con rebosadero	\$ 1,762.00	251
LV MARCUS	Lavabo de sobrecubierta con rebosadero	\$ 2,203.00	250
LV MARCUS BC	Lavabo de bajocubierta con rebosadero	\$ 2,385.00	251
LV MARCUS BC M	Lavabo de bajocubierta con rebosadero. Color marfil	\$ 2,385.00	251
LV MARCUS M	Lavabo de sobrecubierta con rebosadero. Color marfil	\$ 2,203.00	250
LV MOREA	Lavabo de sobreponer sin rebosadero	\$ 1,403.00	249
LV MOREA1	Lavabo de una perforación de sobreponer con rebosadero	\$ 1,578.00	249

AC10-TR011

Cromo

\$ 2,974.00

Regadera de limpieza automática, con válvula de control. Incluye brazo y chapetón.

VÁLVULA DE CONTROL



Dimensiones: vista frontal

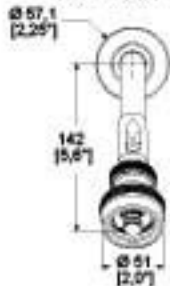

Dimensiones: vista lateral

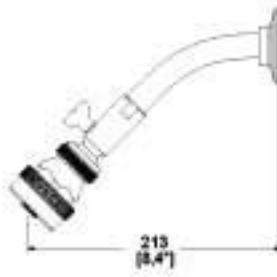

Incluye válvula de control que regula el volumen de agua. Restringe el chorro de agua mientras te enjabonas. No se pierde la mezcla de agua. Presión mínima requerida 0.20 kg/cm². Consumo máximo de agua: 10 L/min.

CR

AC20-TR011

Cromo

\$ 3,777.00

Regadera de limpieza automática, con válvula de control. Incluye brazo y chapetón.

VÁLVULA DE CONTROL



Dimensiones: vista frontal



Dimensiones: vista lateral

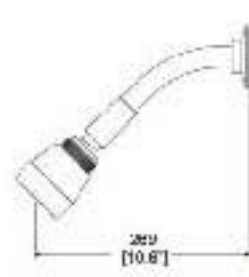

Incluye válvula de control que regula el volumen de agua. Restringe el chorro de agua mientras te enjabonas. No se pierde la mezcla de agua. Presión mínima requerida 0.20 kg/cm². Consumo máximo de agua: 10 L/min.

CR

Estas regaderas cuentan con una **válvula** o una **palanca** que permiten regular el chorro de agua

Limpieza automática: El flujo de agua empuja el disco guía, generando la salida de un chorro adecuado.

Cuando se cierra el flujo de agua, el disco guía regresa a su posición original y el exceso de agua sale en un brusco movimiento, permitiendo que salgan los residuos acumulados.



NOM NOM-008-CONAGUA-1998

REGADERAS DE LIMPIEZA AUTOMÁTICA

AC50-TR011

Cromo

\$ 2,611.00

Regadera de limpieza automática.
Sin válvula de control.
Incluye brazo y chapetón.



Dimensiones
vista frontal

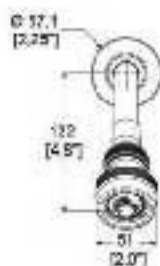

Dimensiones:
vista lateral



Presión mínima requerida 0.20 kg/cm².
Consumo máximo de agua: 10 L/min.

CR

AC-110

Cromo

\$ 3,320.00

Regadera de limpieza automática.
Antirrobo con base al muro.



Dimensiones:
vista frontal

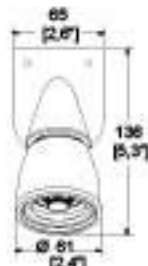

Dimensiones:
vista lateral

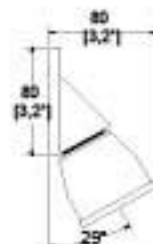

Presión mínima requerida 0.20 kg/cm².
Consumo máximo de agua: 10 L/min.



CR

H1000-TR011

Cromo

\$ 3,801.00

Regadera de chorro regulable.
Incluye brazo y chapetón.



Dimensiones
vista frontal



Dimensiones:
vista lateral

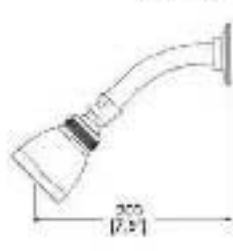

Para aumentar o disminuir el flujo de agua, gire la perilla.
Incluye palanca que permite restringir el chorro de agua mientras te enjabonas.

No se pierde la mezcla de agua.
Presión mínima requerida 1.00 kg/cm².
Consumo máximo de agua: 10 L/min

CR

NOM NOM-008-CONAGUA-1998

KÚBICA

H-3002

Cromo

\$ 10,785.00

Regadera de chorro fijo.
Plato ancho de 8".



Dimensiones:
vista inferior

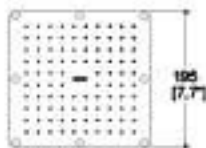

Dimensiones:
vista lateral

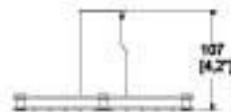

Presión mínima requerida 1.00 kg/cm².
Consumo máximo de agua: 10 L/min.



H-3003

Cromo

\$ 3,406.00

Regadera de chorro fijo.
Plato ancho de 7".



Dimensiones:
vista lateral

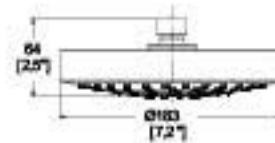

Presión mínima requerida 1.00 kg/cm².
Consumo máximo de agua: 10 L/min.



H-3004

Cromo

\$ 3,406.00

Regadera de chorro fijo.
Plato ancho de 7".



Dimensiones:
vista inferior

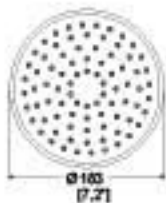

Dimensiones:
vista lateral

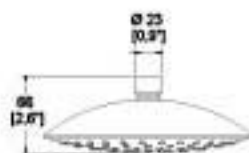

Presión mínima requerida 1.00 kg/cm².
Consumo máximo de agua: 10 L/min.



H-3007

Cromo

\$ 10,520.00

Regadera de chorro fijo.
Plato ancho de 10".



Dimensiones:
vista inferior



Dimensiones:
vista lateral

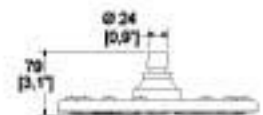

Presión mínima requerida 1.00 kg/cm².
Consumo máximo de agua: 10 L/min.



NOM NOM-008-CONAGUA-1998





Tecnología que proporciona una sensación de abundancia a través de un chorro burbujeante



PREMIER

H-3005

Cromo

\$ 5,723.00

Regadera de chorro fijo con Tecnología Aireavex, plato ancho de 5" x 8".

TRIM **eco**
CIHAC



 Modelo ahorrador
H3005-6

Dimensiones:
vista frontal



Dimensiones:
vista inferior



Se recomienda instalar con brazos TR-035, TR-037 y TR-039 y con la regadera manual de brazo largo RM-14. Presión mínima requerida 1.00 kg/cm². Consumo máximo de agua: 10 L/min.



PREMIER

H3005-TRO35-EB

Ébano

\$ 8,437.00

Regadera de chorro fijo con Tecnología Aireavex, plato ancho de 5" x 8". Incluye brazo y chapetón.



Dimensiones:
vista frontal

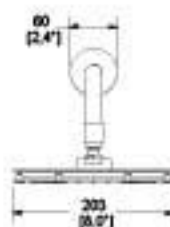

Dimensiones:
vista lateral

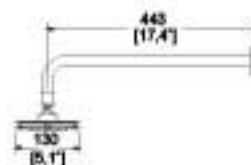

Presión mínima requerida 1.00 kg/cm². Consumo máximo de agua: 10 L/min.



NOM NOM-008-CONAGUA-1998



KÚBICA

H-3006

Cromo

\$7,658.00

Regadera de chorro fijo con Tecnología Aireavex, plato ancho de 6".



Medalla **eco**
CIHAC

Dimensiones
vista frontal



Dimensiones
vista inferior

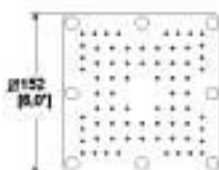

Se recomienda instalar con la regadera manual de brazo largo RM-15. Presión mínima requerida 1.00 kg/cm². Consumo máximo de agua: 9.54 L/min.



KÚBICA

H3006-TR035-EB

Ébano

\$10,664.00

Regadera de chorro fijo con Tecnología Aireavex, plato ancho de 6". Incluye brazo y chapetón.



Dimensiones
vista frontal

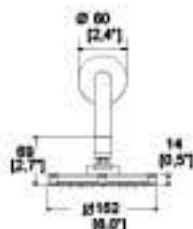

Dimensiones
vista lateral

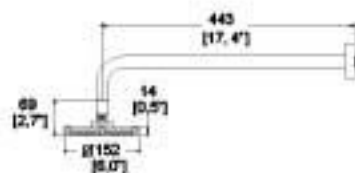

Presión mínima requerida 1.00 kg/cm². Consumo máximo de agua: 9.54 L/min.



NOM NOM-008-CONAGUA-1998



H-3008

Cromo

\$ 9,373.00

Regadera **redonda**
Plato ancho de 8"
(20 cm).
Ultraplana de chorro fijo.
Espesor: 5 mm aprox.



Dimensiones:
vista frontal

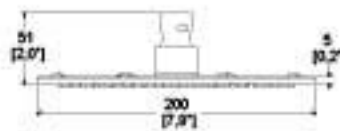

Presión mínima requerida 1.00 kg/cm².
Consumo máximo de agua: 8.7 L/min.



H-3009

Cromo

\$ 9,605.00

Regadera **cuadrada**
Plato ancho de 8" x 8"
(20 x 20 cm).
Ultraplana de chorro fijo.
Espesor: 5 mm aprox.



Dimensiones:
vista frontal



Dimensiones:
vista inferior

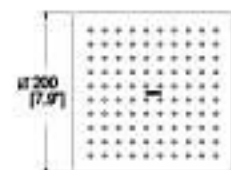

Presión mínima requerida 1.00 kg/cm².
Consumo máximo de agua: 8.7 L/min.



NOM NOM-008-CONAGUA-1998

REGADERAS DE GRAN FORMATO

H-3010

Cromo

\$ 9,405.00



Regadera **redonda**
Plato ancho 12" (30 cm).
Ultraplana de chorro fijo.
Espesor: 5 mm aprox.
No incluye brazo ni chapetón.

Dimensiones:
vista frontal

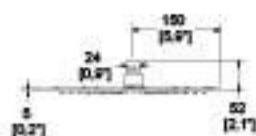

Dimensiones:
vista inferior

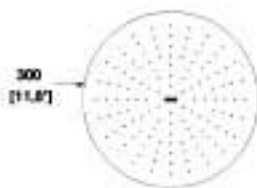

Presión mínima requerida 1.00 kg/cm².
Consumo máximo de agua: 10 L/min.



H-3011

Cromo

\$ 9,637.00



Regadera **cuadrada**
Plato ancho 12" x 12"
(30 cm x 30 cm).
Ultraplana de chorro fijo
Espesor: 5 mm aprox.
No incluye brazo ni chapetón.

Dimensiones:
vista frontal

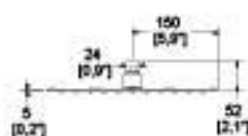

Dimensiones:
vista inferior

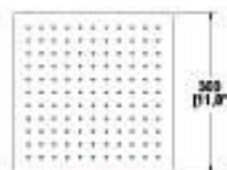

Presión mínima requerida 1.00 kg/cm².
Consumo máximo de agua: 10 L/min.



H-3013

Cromo

\$ 14,701.00



Regadera **cuadrada**
Plato ancho 16" x 16"
(40 cm x 40 cm).
Ultraplana de chorro fijo.
Espesor: 10 mm aprox.
No incluye brazo ni
chapetón.

Dimensiones:
vista frontal

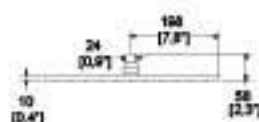

Dimensiones:
vista inferior

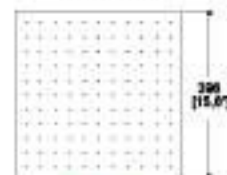

Presión mínima requerida 1.00 kg/cm².
Consumo máximo de agua: 10 L/min.



NOM NOM-008-CONAGUA-1998

Los precios incluyen IVA

133

HELVEX
Cuerpo de Calidad



H-3300

Cromo

\$ 2,298.00

Regadera multichorro 5"
Con botón de cambios
en el plato para
3 tipos de sensaciones
(Lluvia fina, lluvia gruesa
y masaje).
Incluye brazo y chapetón.



Dimensiones:
vista frontal



Dimensiones:
vista lateral

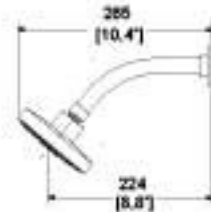

Presión mínima requerida 1.00 kg/cm².
Consumo máximo de agua: 10 L/min.

TIPOS DE CHORRO

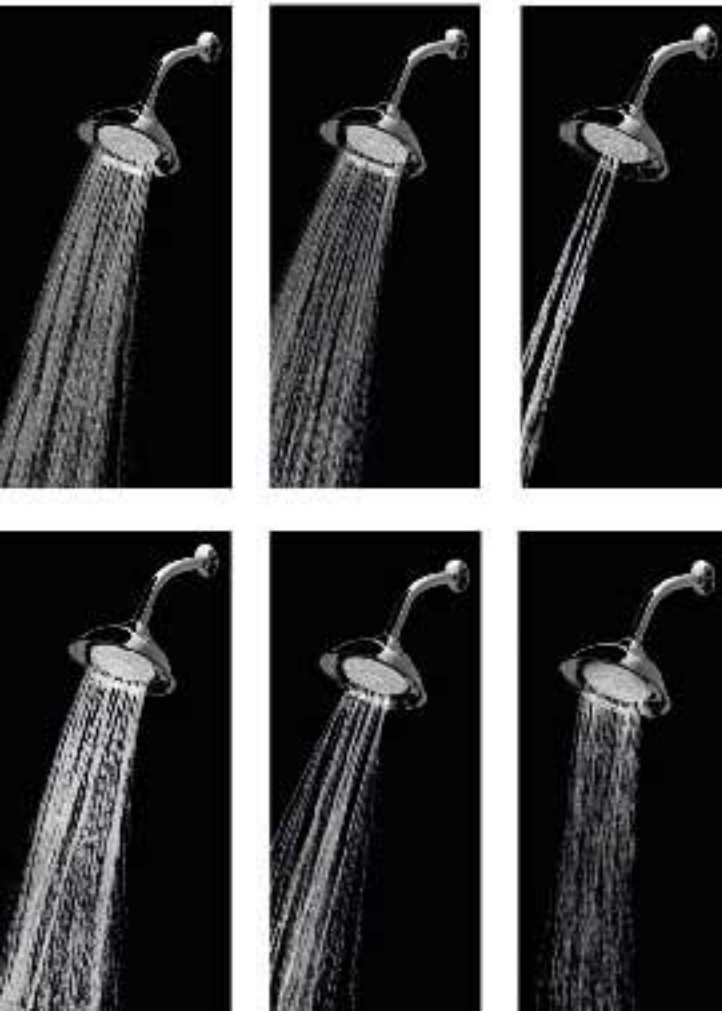

H-3301-C/G

Cromo y plato gris

\$ 2,824.00

Regadera multichorro 7"
Con palanca de cambios
en el plato para
6 tipos de sensaciones
(Libera, activa, disfruta,
relaja, despierta y fusiona).
Incluye brazo y chapetón.



Dimensiones:
vista frontal

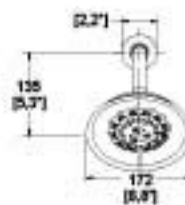

Dimensiones:
vista lateral

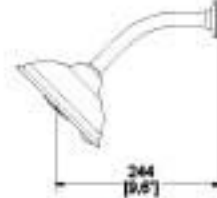

Presión mínima requerida 1.00 kg/cm².
Ahorradora de agua.
Consumo máximo de agua: 10 L/min.

NOM NOM-008-CONAGUA-1998

REGADERAS SWITCH

H-3302

Cromo

\$ 3,976.00



CR



H-3302-C/B

Cromo/blanco

\$ 3,976.00



C/B



Regadera **redonda** multichorro de plato ancho 10" x 10".
Con **botón** de cambios en el plato para
3 tipos de sensaciones (Relaja, fusiona y activa).
Incluye brazo angular 90° y chapetón.

Presión mínima de funcionamiento: 1.00 kg/cm².
Consumo máximo de agua: 10 L/min.



SIEMPRE
ANTICALCÁREO

H-3303

Cromo

\$ 3,976.00



CR



H-3303-C/B

Cromo/blanco

\$ 3,976.00



C/B



Regadera **cuadrada** multichorro de plato ancho 10" x 10".
Con **botón** de cambios en el plato para
3 tipos de sensaciones (Relaja, fusiona y activa).
Incluye brazo angular 90° y chapetón.

Presión mínima de funcionamiento: 1.00 kg/cm².
Consumo máximo de agua: 10 L/min.



SIEMPRE
ANTICALCÁREO

Dimensiones:
vista frontal

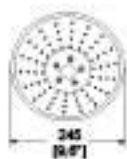

Dimensiones:
vista lateral

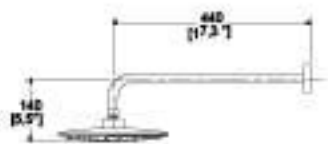

Dimensiones:
vista frontal



Dimensiones:
vista lateral

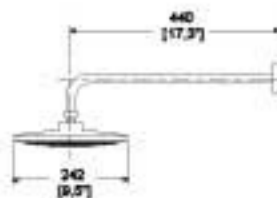

TIPOS DE CHORRO



NOM-008-CONAGUA-1998

ÍNDICE ALFANUMÉRICO

MODELO		DESCRIPCIÓN	PRECIO	PÁGINA
LV NARI	◀ NUEVO	Lavabo de sobreponer sin rebosadero	\$ 3,695.00	244
LV SANTORINI		Lavabo de sobreponer sin rebosadero	\$ 1,757.00	249
LV SANTORINI1		Lavabo de una perforación de sobreponer con rebosadero	\$ 2,091.00	249
LV SIRA	◀ NUEVO	Lavabo de sobreponer sin rebosadero	\$ 3,695.00	244
LV STALA		Lavabo de doble instalación sin rebosadero	\$ 2,260.00	250
LV TRAZZO		Lavabo de sobreponer sin rebosadero	\$ 2,215.00	248
LV TRAZZO M		Lavabo de sobreponer sin rebosadero. Color marfil	\$ 2,215.00	248
M-1004		Konos. Mezcladora de lavabo 8" a 12"	\$ 11,038.00	28
M-1005		Clásica. Mezcladora de lavabo 8" a 12"	\$ 7,904.00	28
M-1006		Nautilia. Mezcladora de lavabo 8" a 12"	\$ 11,081.00	28
MB-1011		Secador de Manos. Con botón accionador	\$ 9,142.00	203
MB-1012		Secador de Manos TURBO. Con sensor	\$ 14,631.00	203
MB-1012-AI		Secador de Manos TURBO. Con sensor	\$ 18,106.00	203
MB-1012-AIB		Secador de Manos TURBO. Con sensor	\$ 18,106.00	203
MB-1100		Dosificador electrónico con sensor para jabón líquido	\$ 6,636.00	204
MB-1101		Dosificador electrónico con sensor para jabón de espuma	\$ 7,773.00	204
MB-1102-AIB		Dosificador electrónico con sensor para jabón líquido	\$ 6,636.00	204
MB-1103-AIB		Dosificador electrónico con sensor para jabón de espuma	\$ 7,773.00	204
ME-302		Tritón. Mezcladora para fregadero	\$ 5,167.00	105
ME-303		Premier. Mezcladora para fregadero con cabezal retráctil magnético	\$ 9,855.00	106
ME-304		Premier. Mezcladora para fregadero. Cabezal móvil 360°	\$ 8,953.00	107
MEP-2004		Iguazú. Mezcladora de lavabo 8" a 12"	\$ 6,436.00	27
MEP-2006		Nuva. Mezcladora de lavabo 8" a 12"	\$ 10,394.00	27
MEP2006-1.9	◀ ECOVEX	Nuva. Mezcladora de lavabo 8" a 12"	\$ 10,394.00	27
MEP-2115		Premier. Mezcladora de lavabo 8" a 12"	\$ 11,225.00	27
MG FERRY	◀ ECOVEX	Mingitorio flujo tipo cascada	\$ 8,691.00	239
MG GOBI TDS2	◀ ECOVEX	Mingitorio seco con sistema TDS2	\$ 11,714.00	242
MG MOJAVE	◀ ECOVEX	Mingitorio flujo tipo cascada	\$ 6,653.00	239
MG MOJAVE TDS2	◀ ECOVEX	Mingitorio seco con sistema TDS2	\$ 8,965.00	241
MG NEGEV TDS2	◀ ECOVEX	Mingitorio seco con sistema TDS2	\$ 11,714.00	241
MI-01-S/C		Elite. Mezcladora de lavabo 4"	\$ 3,577.00	26
MI01-S/C-1.9	◀ ECOVEX	Elite. Mezcladora de lavabo 4"	\$ 3,577.00	26
MI-02-S/C		Primma. Mezcladora de lavabo 4"	\$ 4,051.00	26
MI02-S/C-1.9	◀ ECOVEX	Primma. Mezcladora de lavabo 4"	\$ 4,051.00	26
MP-1000		Vértika. Mezcladora de lavabo 8" a 12"	\$ 11,753.00	27
MR-1001		Vértika. Mezcladora individual de empotrar para regadera	\$ 3,665.00	145
MR-1005		Clásica. Mezcladora individual de empotrar para regadera	\$ 2,449.00	145
NAO 1-3.5		Paquete institucional con fluxómetro de manija y taza	\$ 8,520.00	255
NAO FB-3.5		Paquete institucional con fluxómetro de sensor de baterías y taza	\$ 14,213.00	256
NAO FC-3.5		Paquete institucional con fluxómetro de sensor de corriente y taza	\$ 14,213.00	258
NAO17 1-3.5		Paquete institucional con fluxómetro de manija y taza	\$ 8,520.00	256
NAO17 FB-3.5		Paquete institucional con fluxómetro de sensor de baterías y taza	\$ 14,213.00	257
NAO17 FC-3.5		Paquete institucional con fluxómetro de sensor de corriente y taza	\$ 14,213.00	259
OP CAPRI PLUS	◀ ECOVEX	Inodoro cuadrado. Una sola pieza. Descarga de 4.8 LPD	\$ 11,919.00	218
OP RIVOLI PLUS	◀ ECOVEX	Inodoro elongado. Una sola pieza. Descarga de 4.8 LPD	\$ 11,919.00	217
PD-01-AI		Pedestal para dosificadores de jabón o gel	\$ 3,918.00	205
PIA-100		Piazza. Monomando de lavabo	\$ 3,039.00	47
PIA-100-EB	◀ NUEVO	Piazza. Monomando de lavabo	\$ 3,495.00	47
PIA-101		Piazza alto. Monomando de lavabo	\$ 4,132.00	47
PIA-101-EB	◀ NUEVO	Piazza alto. Monomando de lavabo	\$ 4,752.00	47
PIA-105		Piazza. Toallero de barra	\$ 1,319.00	91
PIA-105-EB	◀ NUEVO	Piazza. Toallero de barra	\$ 1,517.00	92

TR-011

Cromo

\$ 632.00

Brazo y chapetón para regadera.



Dimensiones:
vista frontal

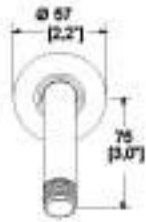

Dimensiones:
vista lateral

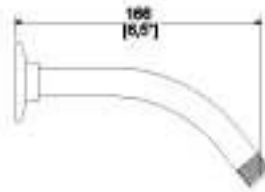

Acabado.



TR-012

Cromo

\$ 695.00

Brazo y chapetón para regadera.



Dimensiones:
vista frontal

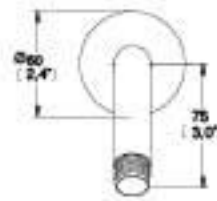

Dimensiones:
vista lateral

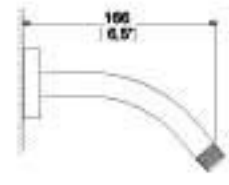

Acabado.



TR-013

Cromo

\$ 805.00

Brazo y chapetón cuadrado para regadera.



Dimensiones:
vista frontal

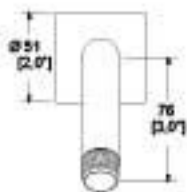

Dimensiones:
vista lateral

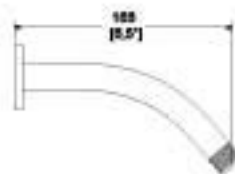

Acabado.



TR-035

Cromo

\$ 1.580.00

Brazo y chapetón angular para regadera de plato ancho.



Dimensiones:
vista lateral

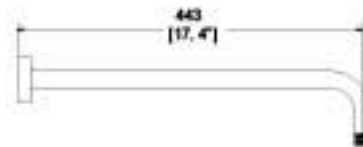

Dimensiones:
vista frontal

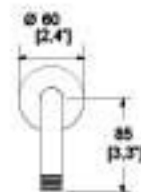

Acabado.



BRAZOS Y CHAPETONES

TR-036

Cromo

\$ 2.258.00

Brazo y chapetón cuadrado para regadera de plato ancho.



Dimensiones:
vista frontal

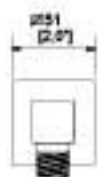

Dimensiones:
vista lateral

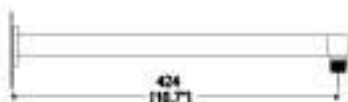

Acabado.



TR-037

Cromo

\$ 1.508.00

Brazo y chapetón al techo redondo para regadera.



Dimensiones:
vista frontal

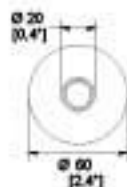

Dimensiones:
vista lateral

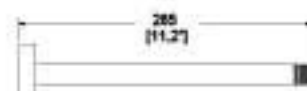

Acabado.



TR-038

Cromo

\$ 1.998.00

Brazo y chapetón al techo cuadrado para regadera.



Dimensiones:
vista frontal

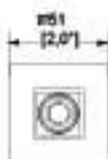

Dimensiones:
vista lateral

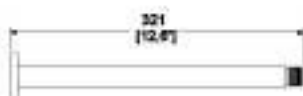

Se recomienda para las regaderas de plato ancho H-3002, H-3006 y H-3009.



TR-039

Cromo

\$ 2.595.00

Brazo y chapetón angular para regadera.



Dimensiones:
vista frontal



Dimensiones:
vista lateral

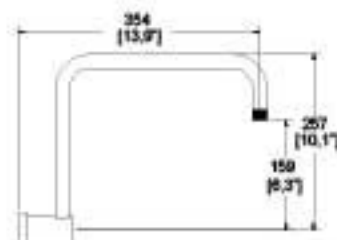

Aumenta la altura de la regadera.



ANTIQUA

RM-5
Cromo

\$7.396.00

Regadera manual con desviador.

Dimensiones:
vista frontal

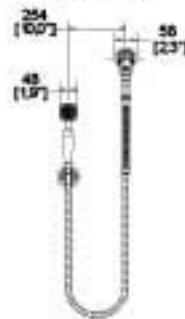

Dimensiones:
vista lateral



Presión mínima requerida 0.20 kg/cm².
Consumo máximo de agua: 10 L/min.
Longitud de la manguera 150 cm.



FUTURA

RM-7
Cromo

\$7.396.00

Regadera manual con desviador.



Dimensiones:
vista frontal

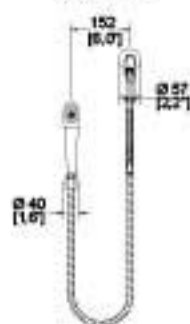

Dimensiones:
vista lateral



Presión mínima requerida 0.20 kg/cm².
Consumo máximo de agua: 10 L/min.
Longitud de la manguera 150 cm.



NOM NOM-008-CONAGUA-1998

REGADERAS MANUALES

VÉRTIKA

RM-13

Cromo

\$ 12,077.00



Regadera manual con desviador. Incluye regadera fija y regadera manual con **3 tipos de chorro**. (Rocío, lluvia fina y lluvia gruesa).



Dimensiones: vista frontal

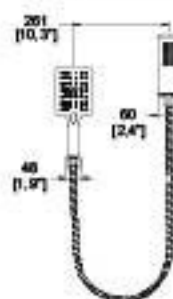

Dimensiones: vista lateral

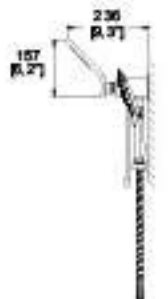

Presión mínima requerida 1.00 kg/cm².
Consumo máximo de agua:
Regadera fija: 9.5 L/min, Regadera Manual: 8.7 L/min.
Longitud de la manguera 150 cm.

CR

RM-14

Cromo

\$ 7,396.00



Regadera manual con desviador y brazo angular redondo para regaderas de plato ancho.



Dimensiones: vista frontal

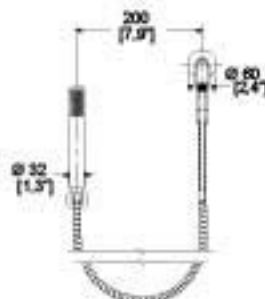

Dimensiones: vista lateral

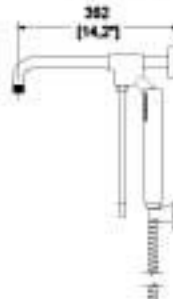

Presión mínima requerida 1.00 kg/cm².
Consumo máximo de agua: 10 L/min.
Longitud de la manguera 150 cm.

CR

RM-15

Cromo

\$ 7,396.00



Regadera manual con **3 tipos de chorro** (Rocío, lluvia fina, lluvia gruesa) desviador y brazo angular, chapetón cuadrado para regaderas de plato ancho.



Dimensiones: vista frontal

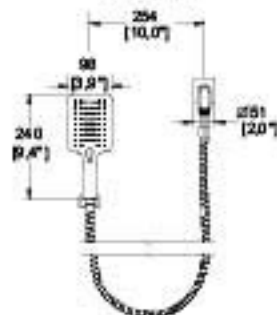

Dimensiones: vista lateral

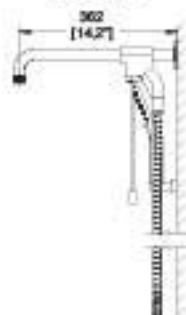

Presión mínima requerida 1.00 kg/cm².
Consumo máximo de agua: 10 L/min.
Regadera manual: 8.7 L/min.
Longitud de la manguera 150 cm.

CR

FUTURA II

RM-17

Cromo

\$ 7,396.00



Regadera manual con desviador.



Dimensiones: vista frontal

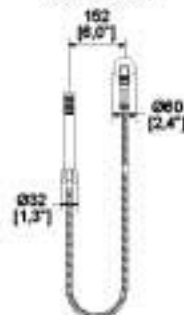

Dimensiones: vista lateral



Presión mínima requerida 0.20 kg/cm².
Consumo máximo de agua: 10 L/min.
Longitud de la manguera 150 cm.

CR

NOM NOM-008-CONAGUA-1998

NUVA
RM12-H101
Cromo

\$ 7,396.00



Regadera manual con desviador. Incluye regadera fija.

Dimensiones: vista frontal

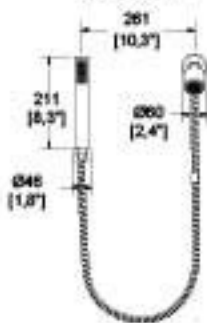

Dimensiones: vista lateral



Presión mínima requerida 0.20 kg/cm².
Consumo máximo de agua: 10 L/min.
Longitud de la manguera 150 cm.



WHIP
RM-30
Cromo

\$ 4,238.00



Regadera manual con soporte móvil. Dos tipos de chorro.



Dimensiones: vista frontal

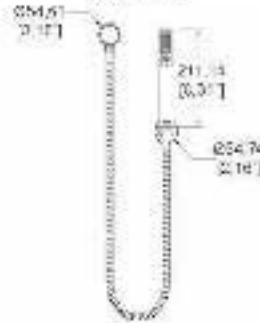

Dimensiones: vista lateral

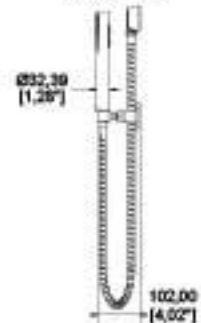

Presión mínima requerida 1.00 kg/cm².
Consumo máximo de agua: 10 L/min.
Longitud de la manguera 150 cm.



WHIP
RM-30-EB
Ébano

\$ 4,874.00



Regadera manual con soporte móvil. Dos tipos de chorro.



Dimensiones: vista frontal

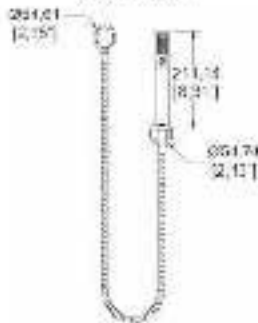

Dimensiones: vista lateral

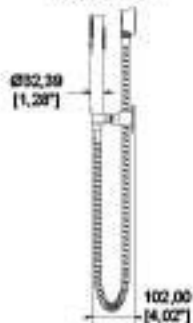

Presión mínima requerida 1.00 kg/cm².
Consumo máximo de agua: 10 L/min.
Longitud de la manguera 150 cm.



NOM NOM-008-CONAGUA-1998

HELVEX
Cemento de Calidad

REGADERAS MANUALES DE ALTURA DESLIZABLE

NUVA

RM-22

Cromo

\$ 5,812.00



Regadera manual de altura deslizable.



Dimensiones vista frontal

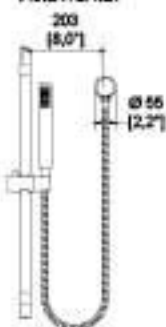

Dimensiones vista lateral



Presión mínima requerida 1.00 kg/cm².
Consumo máximo de agua: 10 L/min.
Longitud de la manguera 150 cm.

CR

RM-23

Cromo

\$ 6,059.00



Regadera manual de altura deslizable.

Dimensiones vista frontal

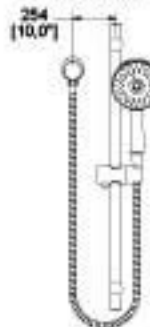

Dimensiones vista lateral

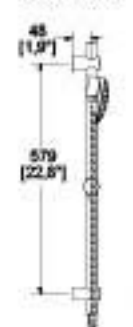

Presión mínima requerida 1.00 kg/cm².
Consumo máximo de agua: 10 L/min.
Longitud de la manguera 150 cm.

CR

RM-24

Cromo

\$ 7,192.00



Regadera manual de altura deslizable,
3 tipos de chorro (lluvia fina, lluvia gruesa y masaje).

Dimensiones vista frontal



Dimensiones vista lateral

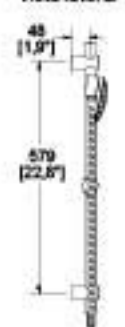

Presión mínima requerida 1.00 kg/cm².
Consumo máximo de agua: 10 L/min.
Longitud de la manguera 150 cm.

CR

RM-25

Cromo

\$ 6,059.00



Regadera manual de altura deslizable.

Dimensiones vista frontal

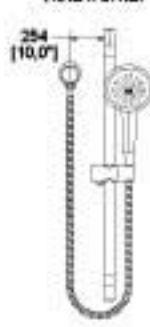

Dimensiones vista lateral

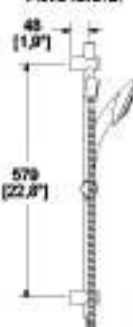

Presión mínima requerida 1.00 kg/cm².
Consumo máximo de agua: 10 L/min.
Longitud de la manguera 150 cm.

CR

NOM NOM-008-CONAGUA-1998

REGADERAS MANUALES DE ALTURA DESLIZABLE

RM-26

Cromo

\$ 7,192.00



SISTEMA ANTICALCÁREO

Regadera manual de altura deslizable. 3 tipos de chorro.



Dimensiones: vista frontal

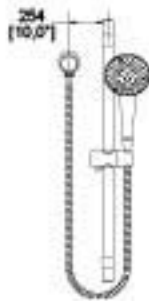

Dimensiones: vista lateral

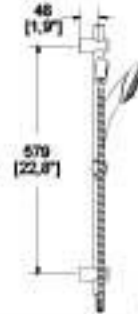

Presión mínima requerida 1,00 kg/cm².
Consumo máximo de agua: 10 L/min.
Longitud de la manguera 150 cm.



RM-27

Cromo

\$ 5,827.00



SISTEMA ANTICALCÁREO

Regadera manual de altura deslizable. 5 tipos de chorro.



Dimensiones: vista frontal

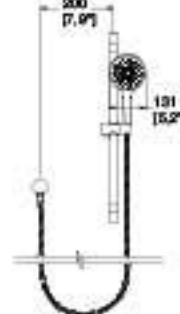

Dimensiones: vista lateral

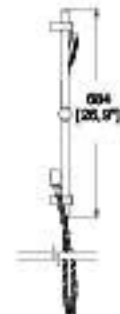

Presión mínima requerida 1,00 kg/cm².
Consumo máximo de agua: 10 L/min.
Longitud de la manguera 150 cm.



RM-28

Cromo

\$ 5,348.00



SISTEMA ANTICALCÁREO

Regadera manual de altura deslizable.



Dimensiones: vista frontal



Dimensiones: vista lateral

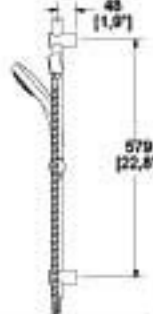

Presión mínima requerida 1,00 kg/cm².
Consumo máximo de agua: 10 L/min.
Longitud de la manguera 150 cm.



RM-29

Cromo

\$ 6,336.00



SISTEMA ANTICALCÁREO

Regadera manual de altura deslizable. 5 tipos de chorro (Rocio, lluvia fina, lluvia gruesa, champagne, masaje).



Dimensiones: vista frontal

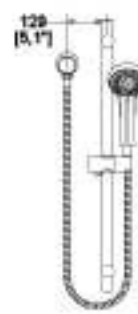

Dimensiones: vista lateral

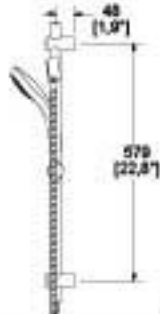

Presión mínima requerida 1,00 kg/cm².
Consumo máximo de agua: 10 L/min.
Longitud de la manguera 150 cm.



NOM NOM-008-CONAGUA-1998

ENSAMBLES PARA REGADERA Y/O TINA

E-40

Cromo

\$ 3.468.00

Ensamble triple de empotrar para regadera y tina. Valvex de compresión.



Dimensiones: vista cenital

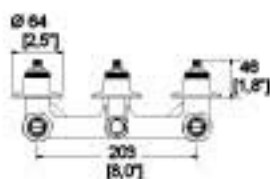

Dimensiones: vista lateral

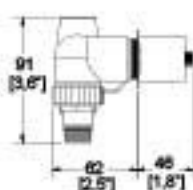

Presión mínima requerida 0.25 kg/cm².



CR

E-40-II

Cromo

\$ 3.468.00

Ensamble triple de empotrar para regadera y tina. Valvex cerámico 1/4 de vuelta.



Dimensiones: vista cenital

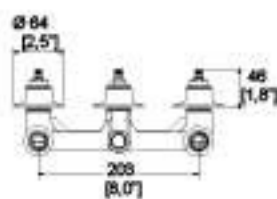

Dimensiones: vista lateral

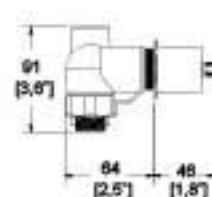

Presión mínima requerida 0.25 kg/cm².



CR

E-40-AQ

Sin chapetones

\$ 3.063.00

Ensamble triple de empotrar para regadera y tina. Valvex cerámico 1/4 de vuelta sin chapetones.



Dimensiones: vista cenital

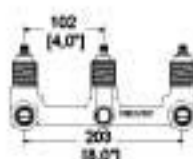

Dimensiones: vista lateral

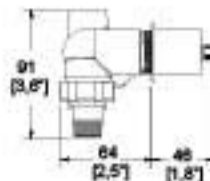

Presión mínima requerida 0.25 kg/cm².

Se surten **sin chapetones** para utilizarse con los manerales Antigua, Konos, Elegance, Nuva, Kúbica, Ática, Antares y Albatros que ya los incluyen.

E-50

Cromo

\$ 2.450.00

Ensamble triple de empotrar para regadera y tina. Valvex de compresión.



E-50-II

Cromo

\$ 2.450.00

Ensamble triple de empotrar para regadera y tina. Valvex cerámico 1/4 de vuelta.

Dimensiones: vista cenital

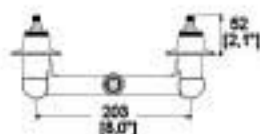

Dimensiones: vista lateral

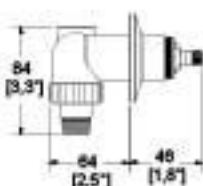

Presión mínima requerida 0.25 kg/cm².



CR

E-50-AQ

Sin chapetones

\$ 2.022.00

Ensamble triple de empotrar para regadera o tina. Valvex cerámico 1/4 de vuelta sin chapetones.



Dimensiones: vista cenital

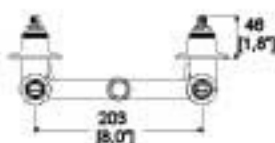

Dimensiones: vista lateral

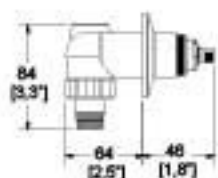

Presión mínima requerida 0.25 kg/cm².

Se surten **sin chapetones** para utilizarse con los manerales Antiqua, Konos, Elegance, Nuva, Kúbica, Ática, Antares y Albatros que ya los incluyen.

E-60

Cromo

\$ 1.390.00

Juego de ensambles individuales de empotrar para regadera. De roscar. Valvex de compresión.



E-60-II

Cromo

\$ 1.390.00

Juego de ensambles individuales de empotrar para regadera. De roscar. Valvex cerámico 1/4 de vuelta.

Dimensiones: vista frontal

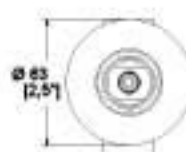

Dimensiones: vista lateral

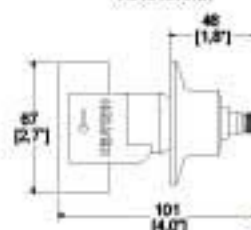

Presión mínima requerida 0.25 kg/cm².



CR

E-60-AQ

Sin chapetones

\$ 1.045.00

Juego de ensambles individuales de empotrar para regadera. De roscar. Valvex cerámico 1/4 de vuelta. Sin chapetones.



Dimensiones: vista frontal

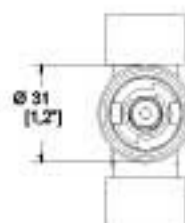

Dimensiones: vista lateral

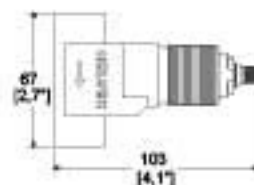

Presión mínima requerida 0.25 kg/cm².

Se surten **sin chapetones** para utilizarse con los manerales Antiqua, Konos, Elegance, Nuva, Kúbica, Ática, Antares y Albatros que ya los incluyen.

E-61

Cromo

\$ 1.390.00

Juego de ensambles individuales de empotrar para regadera. De soldar. Valvex de compresión.



E-61-II

Cromo

\$ 1.390.00

Juego de ensambles individuales de empotrar para regadera. De soldar. Valvex cerámico 1/4 de vuelta.

Dimensiones:
vista frontal



Dimensiones:
vista lateral

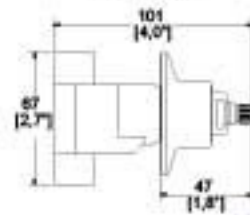

Presión mínima requerida 0.25 kg/cm².

CR

E-61-AQ

Sin chapetones

\$ 1.045.00

Juego de ensambles individuales de empotrar para regadera. De soldar. Valvex cerámico 1/4 de vuelta sin chapetones.



Dimensiones:
vista frontal



Dimensiones:
vista lateral

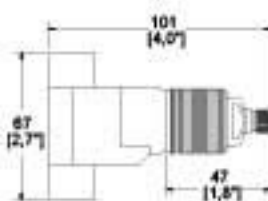

Presión mínima requerida 0.25 kg/cm².

Se surten **sin chapetones** para utilizarse con los manerales Antigua, Konos, Elegance, Nuva, Kúbica, Ática, Antares y Albatros que ya los incluyen.

VÉRTIKA

MR-1001

Cromo

\$ 3.665.00

Mezcladora individual de empotrar para regadera. De roscar. Incluye manerales.



Dimensiones:
vista frontal



Dimensiones:
vista lateral

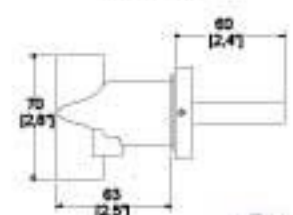

Abre a 1/4 de vuelta.

Presión mínima requerida 0.25 kg/cm².

CR

CLÁSICA

MR-1005

Cromo

\$ 2.449.00

Mezcladora individual de empotrar para regadera. De soldar. Incluye manerales.



Dimensiones:
vista canital

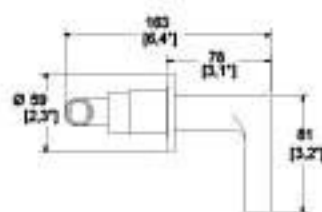

Dimensiones:
vista lateral

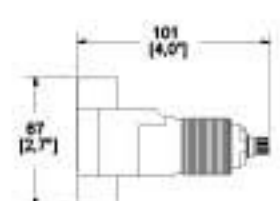

Abre a 1/4 de vuelta.

Presión mínima requerida 0.25 kg/cm².

CR

ÍNDICE ALFANUMÉRICO

MODELO	DESCRIPCIÓN	PRECIO	PÁGINA
PIA-106	Piazza. Gancho sencillo	\$ 389.00	91
PIA-106-EB < NUEVO	Piazza. Gancho sencillo	\$ 447.00	92
PIA-109	Piazza. Toallero sencillo	\$ 593.00	91
PIA-109-EB < NUEVO	Piazza. Toallero sencillo	\$ 682.00	92
PIA-117	Piazza. Portapapel	\$ 618.00	91
PIA-117-EB < NUEVO	Piazza. Portapapel	\$ 711.00	92
PIA-200	Piazza. Monomando para regadera	\$ 2,123.00	153
PIA-200-EB < NUEVO	Piazza. Monomando para regadera	\$ 2,441.00	153
PIU-05	Piura. Toallero de barra	\$ 4,352.00	93
PIU-06	Piura. Gancho sencillo	\$ 1,709.00	93
PIU-09	Piura. Toallero sencillo	\$ 2,703.00	93
PIU-100	Piura. Monomando de lavabo	\$ 10,795.00	49
PIU-101	Piura alto. Monomando de lavabo	\$ 13,597.00	49
PIU-17	Piura. Portapapel	\$ 2,019.00	93
PIU-200	Piura. Monomando para regadera o tina	\$ 7,040.00	157
PIU-201	Piura. Monomando para regadera, tina o regadera manual	\$ 8,014.00	157
REJ-01	Jabonera de rejilla rectangular	\$ 1,976.00	99
REJ-02	Repisa de rejilla esquinera	\$ 2,399.00	99
REJ-03	Repisa de rejilla semicircular doble	\$ 5,767.00	99
REJ-04	Repisa de rejilla rectangular doble	\$ 7,168.00	99
REJ-05	Repisa de rejilla esquinera doble	\$ 7,981.00	100
RM-5	Antiqua. Regadera manual	\$ 7,396.00	138
RM-7	Futura. Regadera manual	\$ 7,396.00	138
RM7-6 < ECOLOGY	Futura. Regadera manual	\$ 7,396.00	138
RM-13	Vértika. Regadera manual	\$ 12,077.00	139
RM-14	Regadera manual	\$ 7,396.00	139
RM-15	Regadera manual	\$ 7,396.00	139
RM-17	Futura II. Regadera manual	\$ 7,396.00	139
RM-22	Nuva. Regadera manual de altura deslizable	\$ 5,812.00	141
RM22-6 < ECOLOGY	Nuva. Regadera manual de altura deslizable	\$ 5,812.00	141
RM-23	Regadera manual de altura deslizable	\$ 6,059.00	141
RM-24	Regadera manual de altura deslizable	\$ 7,192.00	141
RM-25	Regadera manual de altura deslizable	\$ 6,059.00	141
RM-26	Regadera manual de altura deslizable	\$ 7,192.00	142
RM-27	Regadera manual de altura deslizable	\$ 5,827.00	142
RM-28	Regadera manual de altura deslizable	\$ 5,348.00	142
RM-29	Regadera manual de altura deslizable	\$ 6,336.00	142
RM-30 < NUEVO	Whip. Regadera manual con soporte móvil	\$ 4,238.00	140
RM-30-EB < NUEVO	Whip. Regadera manual con soporte móvil	\$ 4,874.00	140
RM12-H101	Nuva. Regadera manual	\$ 7,396.00	140
SS-1	Acondicionador para aguas duras de corriente Sinsarro	\$ 7,781.00	197
S-TZF-P	Soporte para taza TZF Nao a Pared ajustable para dos alturas	\$ 4,511.00	238
TANQUE AUSTRAL	Descarga de 3.8 LPD. Botón accionador	\$ 1,825.00	230
TANQUE AUSTRAL P	Descarga de 3.8 LPD. Palanca accionadora	\$ 1,825.00	231
TANQUE BOLMENI6	Descarga de 4.8 LPD. Botón accionador	\$ 2,221.00	224
TANQUE BOLMENI6 M	Descarga de 4.8 LPD. Botón accionador. Color marfil	\$ 2,221.00	224
TANQUE DRAKAR	Descarga de 4.8 LPD. Botón accionador	\$ 1,820.00	227
TANQUE DRAKAR M	Descarga de 4.8 LPD. Botón accionador. Color marfil	\$ 1,820.00	227
TANQUE DRAKAR16	Descarga de 4.8 LPD. Botón accionador	\$ 1,820.00	228
TANQUE MIURA16	Descarga de 4.8 LPD. Botón accionador	\$ 3,703.00	222
TANQUE MIURA16 TCC	Descarga de 4.8 LPD. Botón de sensor y botón lateral manual	\$ 7,802.00	221
TANQUE MURANO	Descarga de 4.8 LPD. Botón accionador	\$ 4,264.00	219

NOVUS

E-45
Cromo

\$ 4.163.00

Monomando para regadera o tina sin desviador.



Dimensiones:
vista frontal



Dimensiones:
vista lateral



Presión mínima requerida 0.80 kg/cm².

CR

EXPLORA

E-59
Cromo

\$ 4.081.00

Monomando para regadera o tina sin desviador.



Dimensiones:
vista frontal

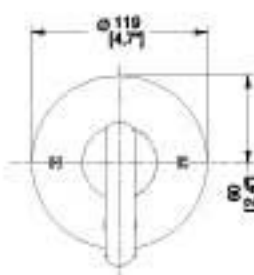

Dimensiones:
vista lateral

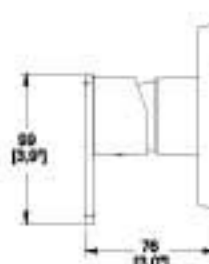

Presión mínima requerida 0.80 kg/cm².

CR

MANTISS

E-72
Cromo

\$ 4.163.00

Monomando para regadera o tina sin desviador.



Dimensiones:
vista frontal

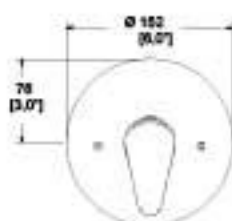

Dimensiones:
vista lateral

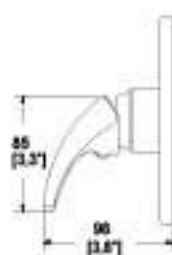

Presión mínima requerida 0.80 kg/cm².

CR

AQUA

E-77
Cromo

\$ 4.188.00

Monomando para regadera o tina sin desviador.



Dimensiones:
vista frontal

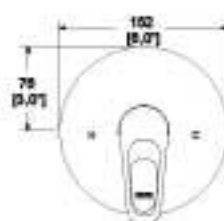

Dimensiones:
vista lateral

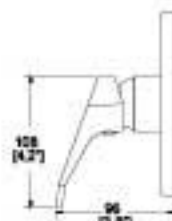

Presión mínima requerida 0.80 kg/cm².

CR

MONOMANDOS PARA REGADERA O TINA

EXPLORA

E-705

Cromo

\$ 4.779.00

Monomando para regadera, tina o regadera manual con desviador.



Dimensiones vista frontal



Dimensiones vista lateral

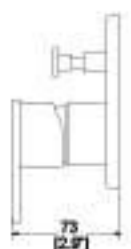

Presión mínima requerida 1.00 kg/cm².

CR

CENTURY

E-708

Cromo

\$ 3.978.00

Monomando para regadera o tina sin desviador.



Dimensiones vista frontal

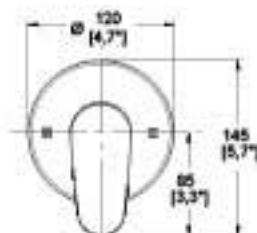

Dimensiones vista lateral

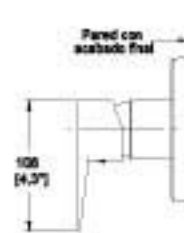

Presión mínima requerida 0.80 kg/cm².

CR

MONOMANDO DE BALANCEO DE PRESIÓN PARA REGADERA O TINA

CENTURY

E-709

Cromo

\$ 4.615.00

Monomando para regadera, tina o regadera manual con desviador.



Dimensiones vista frontal

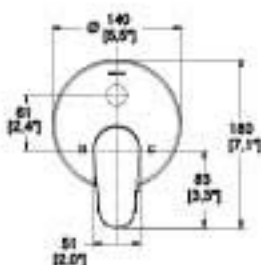

Dimensiones vista lateral



Presión mínima requerida 0.90 kg/cm².

CR

CENTURY

E-791

Cromo

\$ 5.986.00

Monomando de balanceo de presión para regadera, tina o regadera manual con desviador.



Dimensiones vista frontal

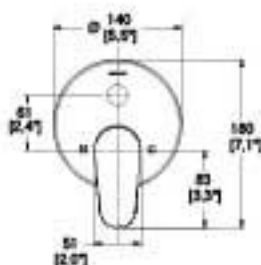

Dimensiones vista lateral

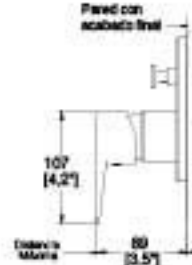

Producto especial, solo sobre pedido.
30 días de entrega a partir del pedido.

Presión mínima requerida 1.20 kg/cm².

CR

INDUS

E-717-EB
Ébano



\$ 5,335.00

Monomando para regadera o tina sin desviador.



Dimensiones:
vista frontal

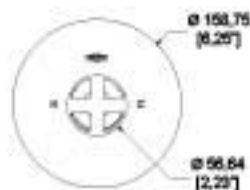

Dimensiones:
vista lateral

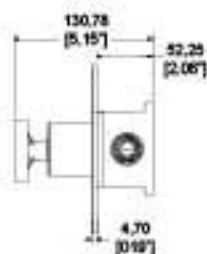

Presión mínima requerida 0.80 kg/cm².

EB

INDUS

E-718-EB
Ébano



\$ 6,030.00

Monomando para regadera o tina con desviador.



Dimensiones:
vista frontal

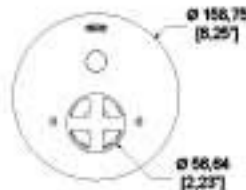

Dimensiones:
vista lateral

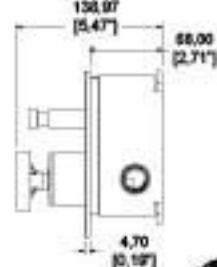

Presión mínima requerida 1.00 kg/cm².

EB

NUVA

E-46
Cromo

\$ 5,481.00

Monomando para regadera o tina sin desviador.



Dimensiones:
vista frontal

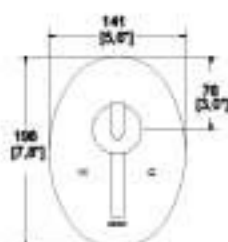

Dimensiones:
vista lateral

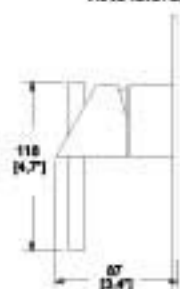

Presión mínima requerida 0.80 kg/cm².

CR

NUVA

E-47
Cromo

\$ 5,750.00

Monomando para regadera, tina o regadera manual con desviador.



Dimensiones:
vista frontal

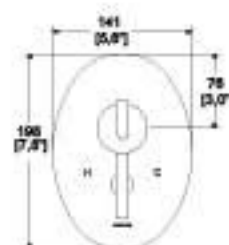

Dimensiones:
vista lateral

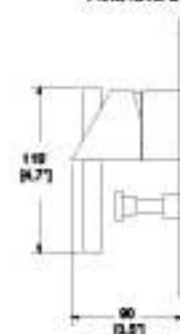

Presión mínima requerida 1.00 kg/cm².

CR

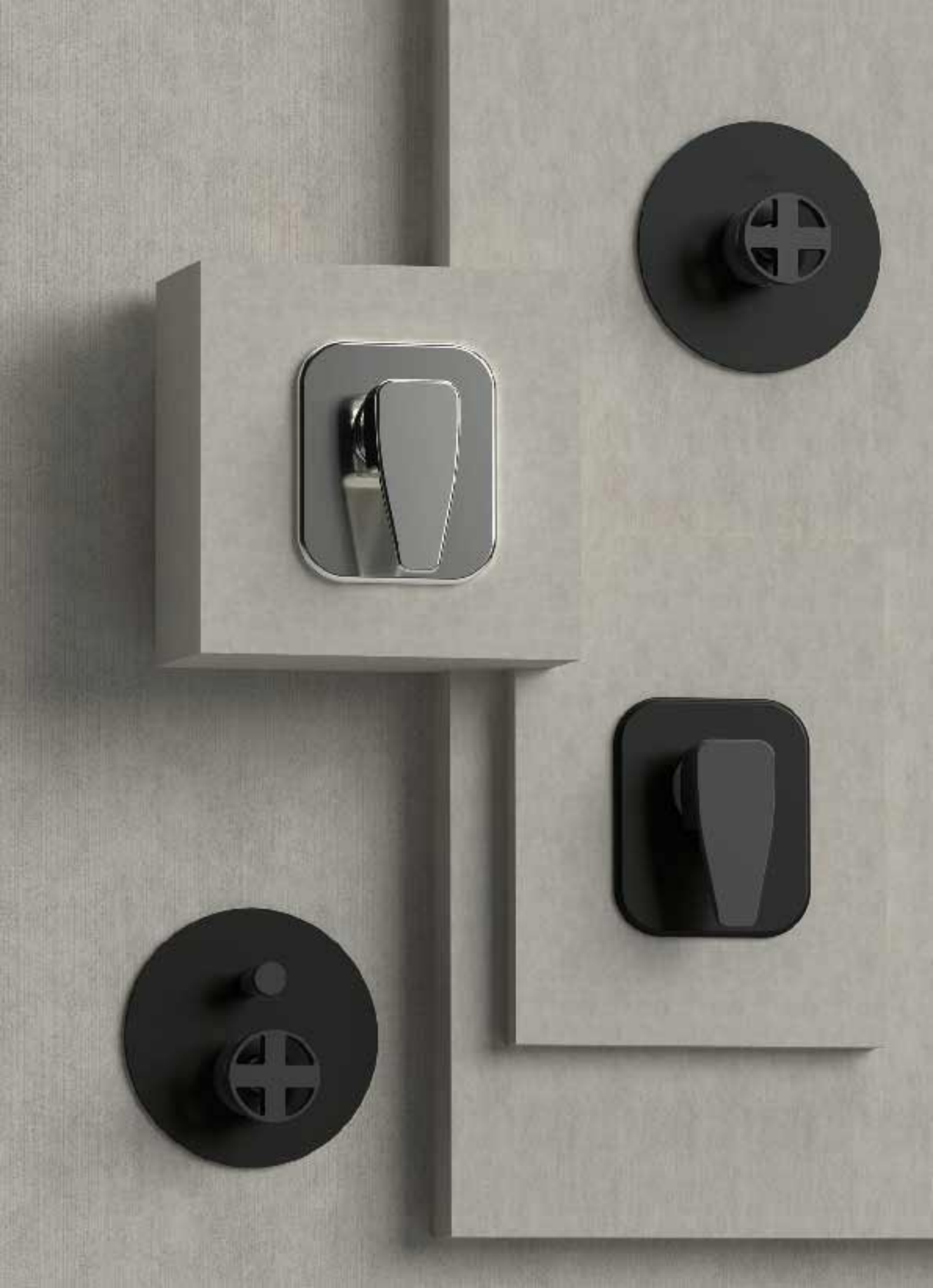

PREMIER

E-702

Cromo

\$ 5.258.00

Monomando para regadera o tina sin desviador.



Presión mínima requerida 0.80 kg/cm².



CR

PREMIER

E-702-EB

Ébano

\$ 4.051.00

Monomando para regadera o tina sin desviador.



Presión mínima requerida 0.80 kg/cm².



EB

Dimensiones:
vista frontal

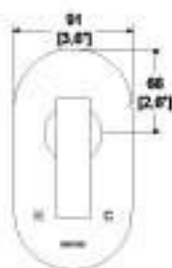

Dimensiones:
vista lateral



PREMIER

E-703

Cromo

\$ 5,960.00

Monomando para regadera, tina o regadera manual con desviador.



Dimensiones vista lateral

Dimensiones vista frontal

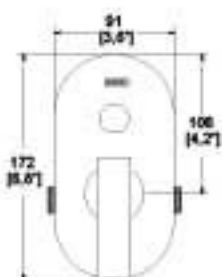

Presión mínima requerida 1.00 kg/cm².



NAUTILIA

E-714

Cromo

\$ 5,381.00

Monomando para regadera o tina, sin desviador.



Dimensiones vista lateral

Dimensiones vista frontal

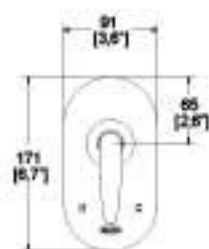

Presión mínima requerida 0.80 kg/cm².



KÚBICA

E-48
Cromo

\$ 6.647.00

Monomando para regadera o tina sin desviador.



Dimensiones:
vista frontal

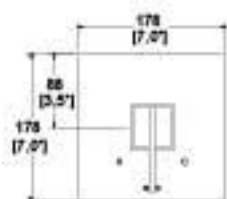

Dimensiones:
vista lateral

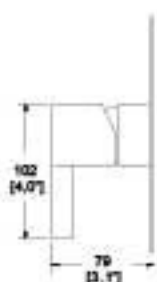

Presión mínima requerida 0.80 kg/cm².

CR

KÚBICA

E-49
Cromo

\$ 7.542.00

Monomando para regadera, tina o regadera manual con desviador.



Dimensiones:
vista frontal

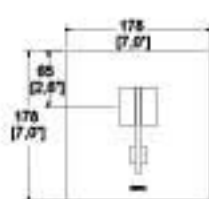

Dimensiones:
vista lateral

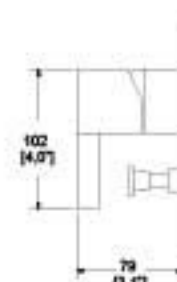

Presión mínima requerida 1.00 kg/cm².

CR

VÉRTIKA

E-700
Cromo

\$ 5.694.00

Monomando para regadera o tina sin desviador.



Dimensiones:
vista frontal

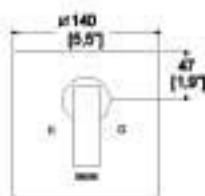

Dimensiones:
vista lateral



Presión mínima requerida 0.80 kg/cm².

CR

VÉRTIKA

E-701
Cromo

\$ 6.267.00

Monomando para regadera, tina o regadera manual con desviador.



Dimensiones:
vista frontal

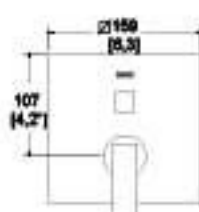

Dimensiones:
vista lateral

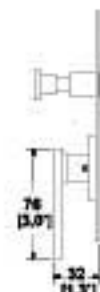

Presión mínima requerida 1.00 kg/cm².

CR

MONOMANDOS PARA REGADERA O TINA

LUSITANIA

LUS-200

Cromo

\$ 2.123.00

Monomando para regadera o tina sin desviador.



Dimensiones:
vista lateral

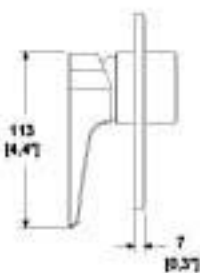

Dimensiones:
vista frontal

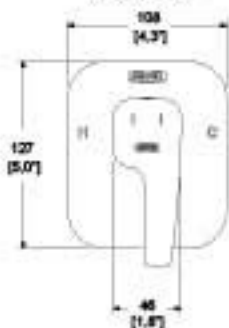

Maneral marcado con indicador de temperatura fría o caliente.
Presión mínima requerida 0.80 kg/cm².



CR

PIAZZA

PIA-200

Cromo

\$ 2.123.00

Monomando para regadera sin desviador.



Maneral marcado con indicador de temperatura fría o caliente.
Presión mínima requerida 0.80 kg/cm².



CR

PIAZZA

PIA-200-EB

Ébano

\$ 2.441.00

Monomando para regadera sin desviador.



Presión mínima requerida 0.80 kg/cm².



EB

Dimensiones:
vista frontal

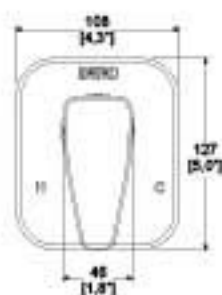

Dimensiones:
vista lateral

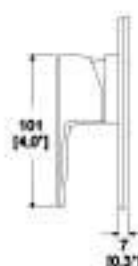



MONOMANDOS PARA REGADERA O TINA

SQUADRA

E-710
Cromo

\$ 4,208.00

Monomando para regadera o tina sin desviador.



Presión mínima requerida 0.80 kg/cm².



CR

SQUADRA

E-710-EB
Ébano

\$ 4,839.00

Monomando para regadera o tina sin desviador.



Presión mínima requerida 0.80 kg/cm².



EB

Dimensiones:
vista frontal

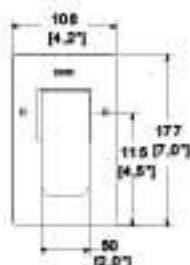

Dimensiones:
vista lateral

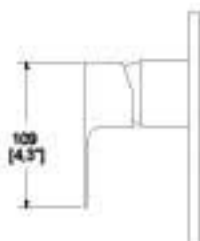

SQUADRA

E-711
Cromo

\$ 5,067.00

Monomando para regadera, tina o regadera manual con desviador.



Dimensiones:
vista frontal

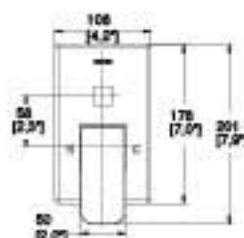

Dimensiones:
vista lateral



Presión mínima requerida 1.00 kg/cm².



CR

MONOMANDO DE BALANCEO DE PRESIÓN PARA REGADERA O TINA

SQUADRA

E-793
Cromo

\$ 6,466.00

Monomando de balanceo de presión para regadera, tina o regadera manual con desviador.



Dimensiones:
vista frontal

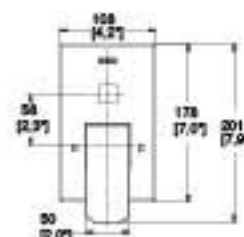

Dimensiones:
vista lateral

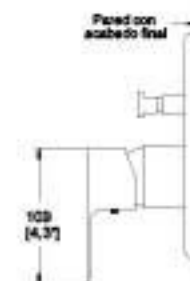

Producto especial, solo sobre pedido.
30 días de entrega a partir del pedido.
Presión mínima requerida 1.20 kg/cm².



CR

ÍNDICE ALFANUMÉRICO

MODELO	DESCRIPCIÓN	PRECIO	PÁGINA
TANQUE OLIMPIA	Descarga de 3.8 LPD. Botón accionador	\$ 1,620.00	226
TANQUE OLIMPIA M	Descarga de 3.8 LPD. Botón accionador. Color marfil	\$ 1,620.00	226
TANQUE OPTION	Descarga de 4.8 LPD. Botón accionador	\$ 1,550.00	229
TANQUE RÓDANO16	Descarga de 4.8 LPD. Botón accionador	\$ 2,221.00	225
TANQUE RÓDANO16 M	Descarga de 4.8 LPD. Botón accionador. Color marfil	\$ 2,221.00	225
TAZA AUSTRAL	Taza elongada compacta y trampa expuesta	\$ 2,144.00	230
TAZA BOLMEN16	Taza elongada y trampa expuesta de altura confortable	\$ 3,334.00	224
TAZA BOLMEN16 M	Taza elongada y trampa expuesta de altura confortable. Color marfil	\$ 3,334.00	224
TAZA DRAKAR	Taza elongada y trampa expuesta.	\$ 2,725.00	227
TAZA DRAKAR M	Taza elongada y trampa expuesta. Color marfil	\$ 2,725.00	227
TAZA DRAKAR16	Taza elongada y trampa expuesta de altura confortable	\$ 2,725.00	228
TAZA MIURA16	Taza elongada y trampa oculta. Desalojo perfecto	\$ 5,555.00	222
TAZA MURANO	Taza elongada y trampa oculta de altura confortable	\$ 6,398.00	219
TAZA OLIMPIA	Taza redonda y trampa expuesta	\$ 2,435.00	226
TAZA OLIMPIA M	Taza redonda y trampa expuesta. Color marfil	\$ 2,435.00	226
TAZA OPTION	Taza elongada compacta y trampa expuesta	\$ 2,329.00	229
TAZA RÓDANO16	Taza elongada y trampa expuesta de altura confortabe	\$ 3,334.00	225
TAZA RÓDANO16 M	Taza elongada y trampa expuesta de altura confortabe. Color marfil	\$ 3,334.00	225
TH-001	Tubo extensión de 37 cm para contra de lavabo	\$ 590.00	55
TH-058	Contra con rejilla para lavabo con rebosadero	\$ 1,504.00	53
TH-059	Contra con rejilla para lavabo sin rebosadero	\$ 1,504.00	53
TH-062	Contra tipo hongo para lavabo con rebosadero	\$ 1,454.00	53
TH-063	Contra tipo hongo para lavabo sin rebosadero	\$ 1,454.00	53
TH-064	Contra de push para lavabo con rebosadero	\$ 1,742.00	54
TH-064-EB ◀ NUEVO	Contra de push para lavabo con rebosadero	\$ 2,003.00	54
TH-065	Contra de push para lavabo sin rebosadero	\$ 1,742.00	54
TH-065-EB ◀ NUEVO	Contra de push para lavabo sin rebosadero	\$ 2,003.00	54
TH-100	Maneral central	\$ 773.00	23
TH-101	Maneral central	\$ 1,114.00	23
TH-148	Elite. Salida para tina a pared	\$ 2,471.00	159
THP-968	Extensión de 17 cm para monomando de lavabo	\$ 2,267.00	35
TR-011	Brazo y chapetón para regadera	\$ 632.00	136
TR-012	Brazo y chapetón para regadera	\$ 695.00	136
TR-013	Brazo y chapetón cuadrado para regadera	\$ 805.00	136
TR-035	Brazo y chapetón angular para regadera de plato ancho	\$ 1,580.00	136
TR-036	Brazo y chapetón cuadrado para regadera de plato ancho	\$ 2,258.00	137
TR-037	Brazo y chapetón al techo redondo para regadera	\$ 1,508.00	137
TR-038	Brazo y chapetón al techo cuadrado para regadera	\$ 1,998.00	137
TR-039	Brazo y chapetón angular para regadera	\$ 2,595.00	137
TUB-05 ◀ NUEVO	Tubular. Toallero de barra	\$ 2,224.00	96
TUB-05-EB ◀ NUEVO	Tubular. Toallero de barra	\$ 2,558.00	97
TUB-06 ◀ NUEVO	Tubular. Gancho sencillo	\$ 743.00	96
TUB-06-EB ◀ NUEVO	Tubular. Gancho sencillo	\$ 855.00	97
TUB-09 ◀ NUEVO	Tubular. Toallero sencillo	\$ 1,099.00	96
TUB-09-EB ◀ NUEVO	Tubular. Toallero sencillo	\$ 1,265.00	98
TUB-10 ◀ NUEVO	Tubular. Portatoallas múltiple	\$ 4,457.00	96
TUB-10-EB ◀ NUEVO	Tubular. Portatoallas múltiple	\$ 5,126.00	98
TUB-17 ◀ NUEVO	Tubular. Portapapel sencillo	\$ 1,527.00	97
TUB-17-EB ◀ NUEVO	Tubular. Portapapel sencillo	\$ 1,755.00	98
TUB-35 ◀ NUEVO	Tubular. Portapapel con soporte de apoyo tipo barra de seguridad	\$ 2,290.00	97
TUB-35-EB ◀ NUEVO	Tubular. Portapapel con soporte de apoyo tipo barra de seguridad	\$ 2,633.00	98
TV-012	Válvula de paso roscable	\$ 807.00	55

MÁXIMA

E-712

Cromo

\$ 4.182.00

Monomando para regadera o tina, sin desviador.



Presión mínima requerida 0.80 kg/cm².

CR

MÁXIMA

E-713

Cromo

\$ 5.067.00

Monomando para regadera, tina o regadera manual, con desviador.



Presión mínima requerida 1.00 kg/cm².

CR

MÁXIMA

E-712-EB

Ébano

\$ 4.809.00

Monomando para regadera o tina, sin desviador.



Presión mínima requerida 0.80 kg/cm².

EB

MÁXIMA

E-713-EB

Ébano

\$ 5.827.00

Monomando para regadera, tina o regadera manual, con desviador.



Presión mínima requerida 1.00 kg/cm².

EB

Dimensiones:
vista frontal

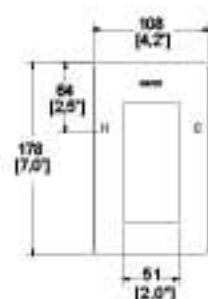

Dimensiones:
vista lateral

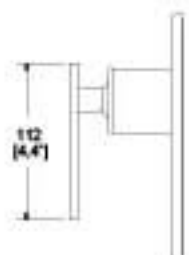

Dimensiones:
vista frontal

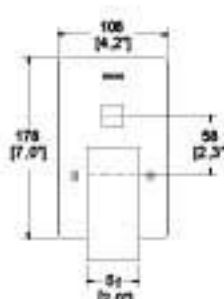

Dimensiones:
vista lateral

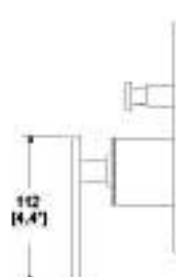

MONOMANDOS PARA REGADERA O TINA

PIURA

PIU-200

Cromo

\$ 7.040.00

Monomando para regadera o tina sin desviador.



Dimensiones
vista frontal



Dimensiones
vista lateral

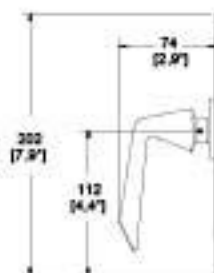

Presión mínima requerida 0.80 kg/cm².

CR

PIURA

PIU-201

Cromo

\$ 8.014.00

Monomando para regadera, tina o regadera manual con desviador.



Dimensiones
vista frontal

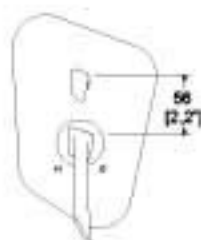

Dimensiones
vista lateral



Presión mínima requerida 1.00 kg/cm².

CR

ACABADOS



CR
Cromo



EB
Ébano

SALIDAS PARA TINA







Salidas de piso.



Salidas a pared.



Visite nuestra página web para consultar y descargar
fichas técnicas e instructivos de instalación.
helvex.com    



HELVEX

Garantía de Calidad



Garantía Helvex en acabado cromo de 10 años y resto de acabados 2 años.

SALIDAS PARA TINA DE PARED

ELITE

TH-148

Cromo

\$ 2.471.00

Salida para tina a pared con desviador.



Dimensiones vista frontal

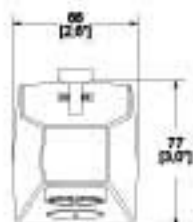

Dimensiones vista lateral



Presión mínima requerida 0.70 kg/cm².



CR

NUVA

TV-060

Cromo

\$ 3.537.00

Salida para tina a pared sin desviador.



Dimensiones vista frontal

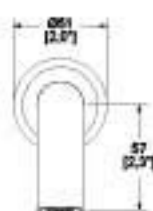

Dimensiones vista lateral

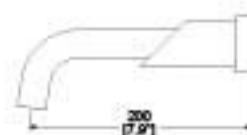

Presión mínima requerida 0.20 kg/cm².



CR

NUVA

TV-061

Cromo

\$ 3.829.00

Salida para tina a pared con desviador.



Dimensiones vista frontal



Dimensiones vista lateral



Presión mínima requerida 0.20 kg/cm².



CR

PREMIER

TV-062

Cromo

\$ 2.621.00

Salida para tina a pared sin desviador.



Dimensiones vista frontal

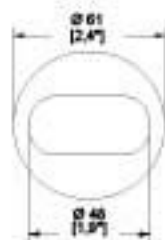

Dimensiones vista lateral

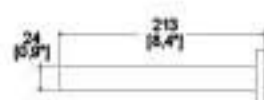

Presión mínima requerida 0.20 kg/cm².



CR

PREMIER

TV-062-EB

Ébano

\$ 3 015.00

Salida para tina a pared sin desviador.



Dimensiones: vista frontal



Dimensiones: vista lateral

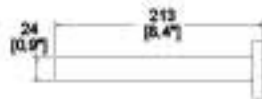

Presión mínima requerida 0.20 kg/cm².



EB

OLIMPO

TV-064

Cromo

\$ 2 187.00

Salida para tina a pared sin desviador.



Dimensiones: vista frontal

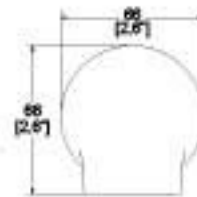

Dimensiones: vista lateral

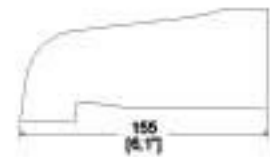

Presión mínima requerida 0.20 kg/cm².



CR

SALIDA PARA TINA DE PISO

VÉRTIKA

TV-069

Cromo

\$ 3 940.00

Salida para tina a pared con desviador.



Dimensiones: vista frontal

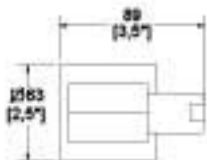

Dimensiones: vista lateral

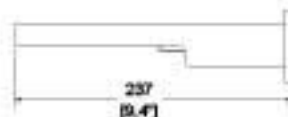

Presión mínima requerida 0.20 kg/cm².



CR

VÉRTIKA

TV-081

Cromo

\$ 7 016.00

Salida para tina a piso sin desviador.



Dimensiones: vista frontal

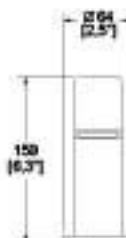

Dimensiones: vista lateral

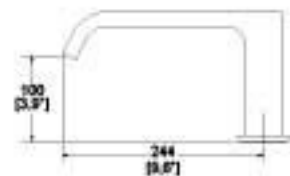

Presión mínima requerida 0.20 kg/cm².



CR

DESAGÜE PARA TINA

H-7190

Cromo

\$ 3.376.00

Desagüe para tina con sistema de push.



Dimensiones:
vista frontal



Dimensiones:
vista lateral

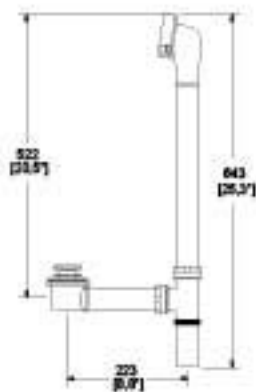

Acabado.



CR

COLADERAS



COLADERAS



Coladeras para piso en interiores.



- Cuerpo de hierro fundido.
- Plato de doble drenaje para evitar la humedad en el piso inferior de la construcción.
- Contras ajustables para colocarlas a diferentes alturas según el nivel del piso.
- Rejillas y casquillos removibles para mejor limpieza y mantenimiento.
- Césped integral que produce un sello hidráulico y evita malos olores.
- Recomendable para baños, regaderas, vestíbulos u otras áreas interiores.



Coladeras para piso en exteriores.



- Sello hidráulico de campana para evitar el paso de gases de las líneas de drenaje a la coladera.
- Recomendables para patios, terrazas, fábricas, plantas industriales, garages, cubos de elevador y lavanderías.



Coladeras para azotea.



- Rejillas removibles.
- Aditamento para colocación del impermeabilizante.
- Para colocarse en las bajadas pluviales situadas en el pretil de las azoteas.



Rebosaderos.



- Cuerpo de latón fundido y rejilla removible.
- Rejillas con gran capacidad de drenado (Redondos, cuadrados y rectangulares).
- Recomendable para pasillos y corredores.



Válvulas para drenaje.







- Tapa de registro removible.
- Conexiones de campana y espiga para que pueda instalarse en tubería de drenaje.
- Compuerta de latón que cierra a la menor presión en sentido contrario e impide el regreso de aguas negras.



Interceptores de Grasa.



- Construidos en placa cold rolled.
- Gran resistencia a la corrosión y oxidación por su capa de galvanizado.
- Tapa de registro corrugada antiderapante para evitar accidentes.
- Para usarse en restaurantes o comedores industriales.
- Pueden ser expuestos o soterrados.

Visite nuestra página web para consultar y descargar fichas técnicas e instructivos de instalación.
helvex.com    



ÍNDICE ALFANUMÉRICO

MODELO	DESCRIPCIÓN	PRECIO	PÁGINA
TV-016	Césped para lavabo con registro	\$ 1,725.00	56
TV-016-EB (NUEVO	Césped para lavabo con registro	\$ 1,984.00	56
TV-016-40	Césped para lavabo de 40 cm de largo con registro	\$ 2,163.00	56
TV-016-40-EB (NUEVO	Césped para lavabo de 40 cm de largo con registro	\$ 2,487.00	56
TV-017	Césped para lavabo con registro	\$ 1,999.00	57
TV-017-EB (NUEVO	Césped para lavabo con registro	\$ 2,299.00	57
TV-017-40	Césped para lavabo de 40 cm de largo con registro	\$ 2,295.00	57
TV-017-40-EB (NUEVO	Césped para lavabo de 40 cm de largo con registro	\$ 2,639.00	57
TV-030	Césped para fregadero con registro	\$ 2,481.00	119
TV-031	Conexión para céspol. Tarja doble	\$ 2,220.00	119
TV-060	Nuva. Salida para tina a pared	\$ 3,537.00	159
TV-061	Nuva. Salida para tina a pared	\$ 3,829.00	159
TV-062	Premier. Salida para tina a pared	\$ 2,621.00	159
TV-062-EB	Premier. Salida para tina a pared	\$ 3,015.00	160
TV-064	Olimpo. Salida para tina a pared	\$ 2,187.00	160
TV-069	Vértika. Salida para tina a pared	\$ 3,940.00	160
TV-081	Vértika. Salida para tina a piso	\$ 7,016.00	160
TV-100	Llave de lavabo economizadora a pared	\$ 3,874.00	187
TV-105	Llave de lavabo economizadora	\$ 3,692.00	187
TV105-2 (ECOLOVER	Llave de lavabo economizadora	\$ 3,692.00	187
TV-106	Stala. Llave de lavabo economizadora	\$ 3,479.00	188
TV-121	Llave de lavabo temporizadora a pared	\$ 4,452.00	188
TV121-1.9 (ECOLOVER	Llave de lavabo economizadora a pared	\$ 4,452.00	188
TV-122	Llave de lavabo temporizadora a piso	\$ 4,245.00	188
TV122-1.9 (ECOLOVER	Llave de lavabo economizadora a piso	\$ 4,245.00	188
TV-190	Nimbus. Llave de lavabo electrónica de proximidad. De baterías de litio 6V	\$ 16,145.00	191
TV190-1.9 (ECOLOVER	Nimbus. Llave de lavabo electrónica de proximidad. De baterías de litio 6V	\$ 16,145.00	191
TV-200	Nuva. Llave de lavabo electrónica de sensor a pared. De baterías alcalinas AA	\$ 15,545.00	191
TV-200-C	Nuva. Llave de lavabo electrónica de sensor a pared. De corriente	\$ 16,379.00	191
TV-201	Llave de lavabo electrónica de sensor a pared. De baterías alcalinas AA	\$ 15,545.00	183
TV201-1.9 (ECOLOVER	Llave de lavabo electrónica de sensor a pared. De baterías alcalinas AA	\$ 15,545.00	183
TV-201-C	Llave de lavabo electrónica de sensor a pared. De corriente	\$ 16,379.00	183
TV201-C-1.9 (ECOLOVER	Llave de lavabo electrónica de sensor a pared. De corriente	\$ 16,379.00	183
TV-203	Llave de lavabo electrónica de sensor a pared. De baterías alcalinas AA	\$ 15,545.00	184
TV203-1.9 (ECOLOVER	Llave de lavabo electrónica de sensor a pared. De baterías alcalinas AA	\$ 15,545.00	184
TV-203-C	Llave de lavabo electrónica de sensor a pared. De corriente	\$ 16,379.00	184
TV203-C-1.9 (ECOLOVER	Llave de lavabo electrónica de sensor a pared. De corriente	\$ 16,379.00	184
TV-296	Argos. Llave de lavabo electrónica de sensor. De baterías alcalinas AA	\$ 15,545.00	192
TV296-1.9 (ECOLOVER	Argos. Llave de lavabo electrónica de sensor. De baterías alcalinas AA	\$ 15,545.00	192
TV-296-C	Argos. Llave de lavabo electrónica de sensor. De corriente	\$ 16,379.00	192
TV296-C-1.9 (ECOLOVER	Argos. Llave de lavabo electrónica de sensor. De corriente	\$ 16,379.00	192
TV-297	Alfa. Llave de lavabo electrónica de sensor. De baterías alcalinas AA	\$ 15,545.00	192
TV297-1.9 (ECOLOVER	Alfa. Llave de lavabo electrónica de sensor. De baterías alcalinas AA	\$ 15,545.00	192
TV-297-C	Alfa. Llave de lavabo electrónica de sensor. De corriente	\$ 16,379.00	192
TV297-C-1.9 (ECOLOVER	Alfa. Llave de lavabo electrónica de sensor. De corriente	\$ 16,379.00	192
TV-298	Omega. Llave de lavabo electrónica de sensor. De baterías alcalinas AA	\$ 15,545.00	193
TV298-1.9 (ECOLOVER	Omega. Llave de lavabo electrónica de sensor. De baterías alcalinas AA	\$ 15,545.00	193
TV-298-C	Omega. Llave de lavabo electrónica de sensor. De corriente	\$ 16,379.00	193
TV298-C-1.9 (ECOLOVER	Omega. Llave de lavabo electrónica de sensor. De corriente	\$ 16,379.00	193
TV-302	Líquida. Llave de lavabo electrónica de sensor. De baterías alcalinas AA	\$ 15,545.00	194
TV302-1.5 (ECOLOVER	Líquida. Llave de lavabo electrónica de sensor. De baterías alcalinas AA	\$ 15,545.00	194
TV-302-B	Líquida. Llave de lavabo electrónica de sensor. De baterías alcalinas AA	\$ 17,877.00	194

COLADERAS



Con rejillas redondas, cuadradas y rectangulares.

Coladeras decorativas, con desagües de contorno para incrustar cerámicos.



Coladeras de una, dos y tres bocas.

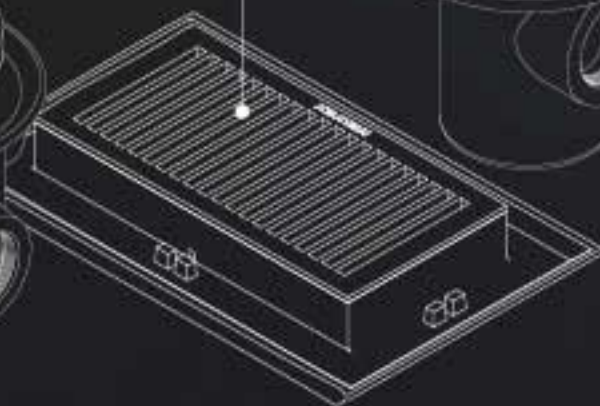

Sello hidráulico que evita el paso de malos olores.

COLADERAS ADAPTABLES SEGÚN LAS NECESIDADES.

INTERIORES Y EXTERIORES PARA AZOTEAS, PATIOS Y ZONAS DE GRAN AFLUENCIA

HELVEX

Garantía de Calidad

COLADERAS CORTAS

PARA ENTREPISOS MÁS DELGADOS

FABRICADAS
DE HIERRO FUNDIDO,
LATÓN Y ACERO
INOXIDABLE

Boca lateral



Boca vertical



Cápsul de polietileno de alta densidad

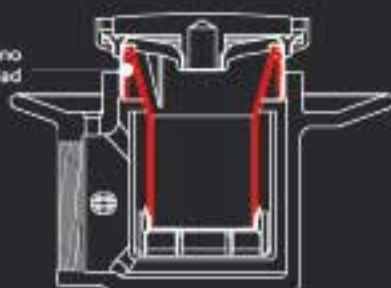

Entrepisos más delgados

Contra ajustable para colocar a diferentes alturas según el nivel del piso

Plato de drenado antifiltraciones

Sello hidráulico que impide el paso de malos olores

22

\$ 1.772.00

Coladera corta de una boca lateral, de rejilla redonda removible.



Dimensiones:
vista cenital

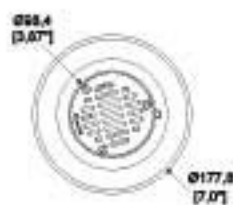

Dimensiones:
vista lateral

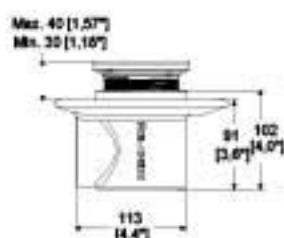

Ideal para las nuevas tendencias de la construcción, donde los entrepisos son más delgados. Cuerpo de hierro fundido.

22-CH

\$ 1.939.00

Coladera corta de una boca lateral, de rejilla cuadrada removible.



Dimensiones:
vista cenital

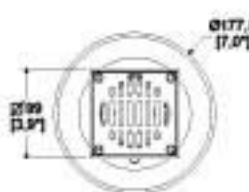

Dimensiones:
vista lateral

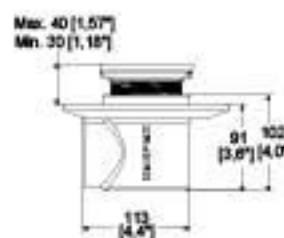

Ideal para las nuevas tendencias de la construcción, donde los entrepisos son más delgados. Cuerpo de hierro fundido.

22-CHL

\$ 2.248.00

Coladera corta de una boca lateral, desagüe de contorno cuadrado, tapa removible.



Dimensiones:
vista cenital

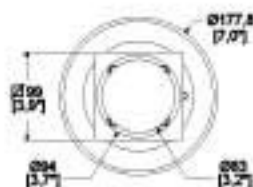

Dimensiones:
vista lateral

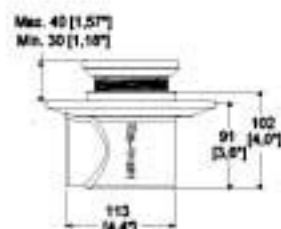

Ideal para las nuevas tendencias de la construcción, donde los entrepisos son más delgados. Cuerpo de hierro fundido.

22-CHLI

\$ 2.248.00

Coladera corta de una boca lateral, desagüe de contorno cuadrado, portainsero removible.



Dimensiones:
vista cenital

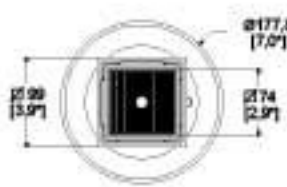

Dimensiones:
vista lateral

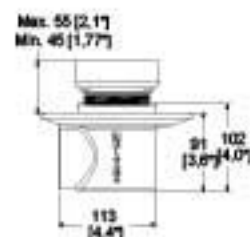

Ideal para las nuevas tendencias de la construcción, donde los entrepisos son más delgados. Cuerpo de hierro fundido.

COLADERAS PARA PISO EN INTERIORES DE UNA BOCA

22-HL

\$ 2.087.00

Coladera corta de una boca lateral, desagüe de contorno redondo, tapa removible.



Dimensiones:
vista cenital



Dimensiones:
vista lateral

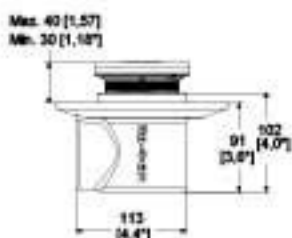

Ideal para las nuevas tendencias de la construcción, donde los entrepisos son más delgados. Cuerpo de hierro fundido.

22-HLI

\$ 2.087.00

Coladera corta de una boca lateral, desagüe de contorno redondo, portainsero removible.



Dimensiones:
vista cenital

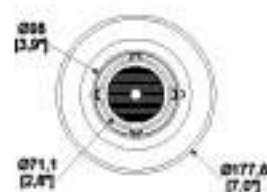

Dimensiones:
vista lateral

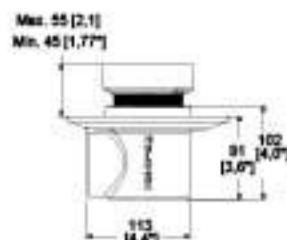

Ideal para las nuevas tendencias de la construcción, donde los entrepisos son más delgados. Cuerpo de hierro fundido.



22V

\$ 1.772.00

Coladera corta de una boca vertical, de rejilla redonda removible.



Dimensiones:
vista cenital

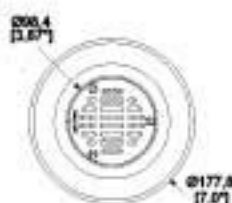

Dimensiones:
vista lateral

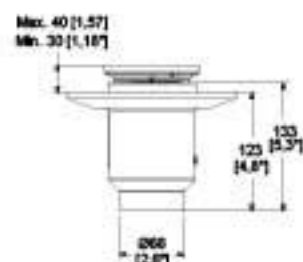

Por la ubicación de su conexión reduce tiempos y costos de instalación, conexiones adicionales y se adapta a cualquier espesor de losa. Para entrepisos más delgados. Cuerpo de hierro fundido.

22V-CH

\$ 1.939.00

Coladera corta de una boca vertical, de rejilla cuadrada removible.



Dimensiones:
vista cenital

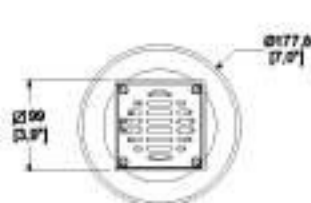

Dimensiones:
vista lateral

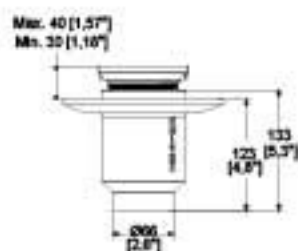

Por la ubicación de su conexión reduce tiempos y costos de instalación, conexiones adicionales y se adapta a cualquier espesor de losa. **Para entrepisos más delgados.** Cuerpo de hierro fundido.

22V-CHL

\$ 2.248.00

Coladera corta de una boca vertical, desagüe de contorno cuadrado, tapa removible.



Dimensiones:
vista cenital

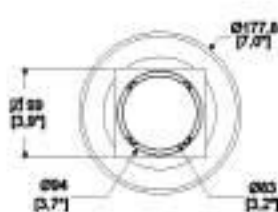

Dimensiones:
vista cenital

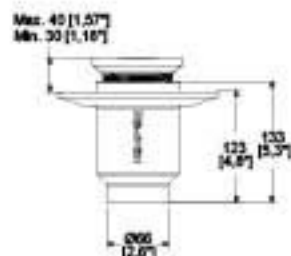

Por la ubicación de su conexión reduce tiempos y costos de instalación, conexiones adicionales y se adapta a cualquier espesor de losa. **Para entrepisos más delgados.** Cuerpo de hierro fundido.

22V-CHLI

\$ 2.248.00

Coladera corta de una boca vertical, desagüe de contorno cuadrado, portainsero removible



Dimensiones:
vista cenital

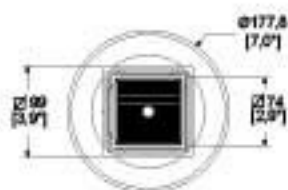

Dimensiones:
vista lateral

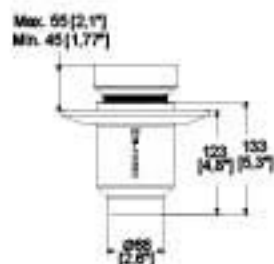

Por la ubicación de su conexión reduce tiempos y costos de instalación, conexiones adicionales y se adapta a cualquier espesor de losa. **Para entrepisos más delgados.** Cuerpo de hierro fundido.



COLADERAS PARA PISO EN INTERIORES DE UNA BOCA

22V-HL

\$ 2.087.00

Coladera corta de una boca vertical, desagüe de contorno redondo, tapa removible.



Dimensiones:
vista cenital



Dimensiones:
vista lateral

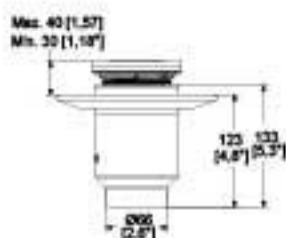

Por la ubicación de su conexión reduce tiempos y costos de instalación, conexiones adicionales y se adapta a cualquier espesor de losa. Para entrepisos más delgados. Cuerpo de hierro fundido.

22V-HLI

\$ 2.087.00

Coladera corta de una boca vertical, desagüe de contorno redondo, portainsero removible.



Dimensiones:
vista cenital

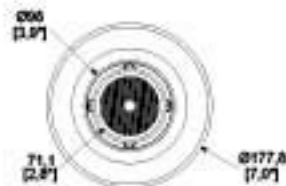

Dimensiones:
vista lateral

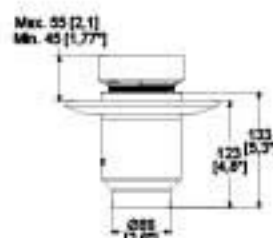

Por la ubicación de su conexión reduce tiempos y costos de instalación, conexiones adicionales y se adapta a cualquier espesor de losa. Para entrepisos más delgados. Cuerpo de hierro fundido.



24

\$ 1.772.00

Coladera de una boca, de rejilla redonda.



Dimensiones:
vista cenital

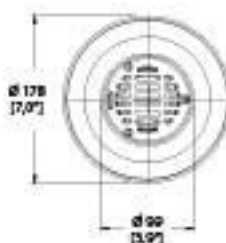

Dimensiones:
vista lateral

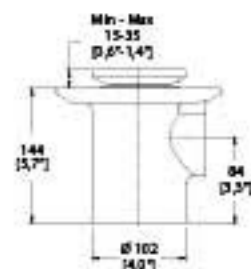

Sello hidráulico.
No permite el paso de malos olores.
Cuerpo de hierro fundido.

24-CH

\$ 1.939.00

Coladera de una boca, de rejilla cuadrada.



Dimensiones:
vista cenital



Dimensiones:
vista lateral

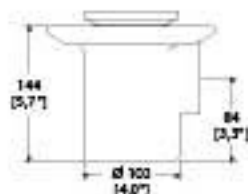

Sello hidráulico.
No permite el paso de malos olores.
Cuerpo de hierro fundido.

24-CHL

\$ 2.248.00

Coladera de una boca, tapa redonda desagüe de contorno cuadrado.



Dimensiones:
vista cenital



Dimensiones:
vista lateral

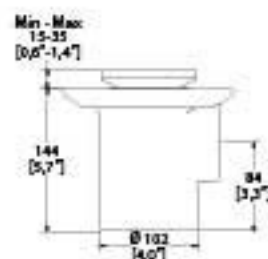

Sello hidráulico.
No permite el paso de malos olores.
Cuerpo de hierro fundido.

24-CHLI

\$ 2.248.00

Coladera de una boca, desagüe de contorno cuadrado para inserto cerámico máximo de 10 mm.



Dimensiones:
vista cenital



Dimensiones:
vista lateral

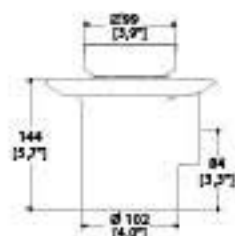

Sello hidráulico.
No permite el paso de malos olores.
Cuerpo de hierro fundido.



COLADERAS PARA PISO EN INTERIORES DE UNA BOCA

24-HL

\$ 2.087.00

Coladera de una boca, desagüe de contorno tapa redonda.



Dimensiones:
vista cenital

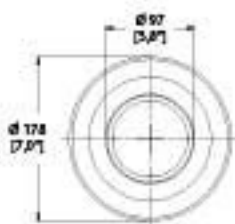

Dimensiones:
vista lateral

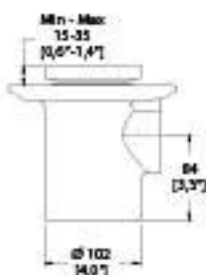

Sello hidráulico.
No permite el paso de malos olores.
Cuerpo de hierro fundido.

24-HLI

\$ 2.087.00

Coladera de una boca, desagüe de contorno redondo para inserto cerámico máximo de 10 mm.



Dimensiones:
vista cenital



Dimensiones:
vista lateral

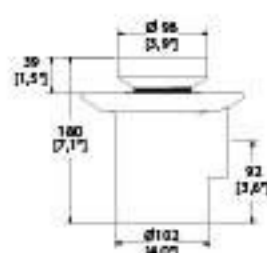

Sello hidráulico.
No permite el paso de malos olores.
Cuerpo de hierro fundido.

24-RHLI

\$ 5.139.00

Coladera rectangular de una boca, desagüe de contorno rectangular para inserto cerámico máximo de 10 mm.



Dimensiones:
vista cenital

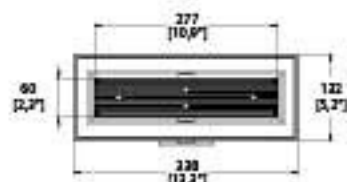

Dimensiones:
vista lateral

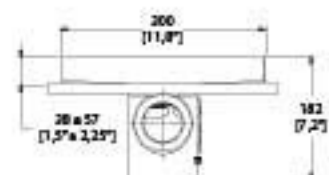

Sello hidráulico.
No permite el paso de malos olores.
Cuerpo de hierro fundido.



24-RHLI-60

\$ 7.829.00

Coladera decorativa alargada de 60 cm, perfil de latón con charola de acero inoxidable y base de hierro gris.



Dimensiones:
vista cenital

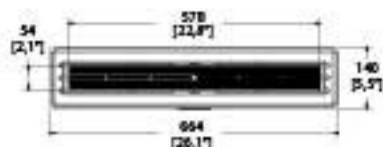

Dimensiones:
vista lateral



Sello hidráulico.
No permite el paso de malos olores.
Cuerpo de hierro fundido.

24-RHLI-90

\$ 10.277.00

Coladera decorativa alargada de 90 cm, perfil de latón con charola de acero inoxidable y base de hierro gris.



Dimensiones:
vista cenital

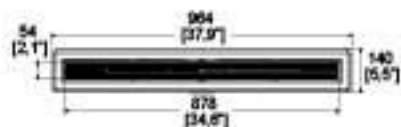

Dimensiones:
vista lateral

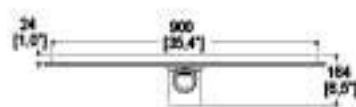

Sello hidráulico.
No permite el paso de malos olores.
Cuerpo de hierro fundido.

27

\$ 2.314.00

Coladera alta de una boca, rejilla redonda de 25 cm.



Dimensiones:
vista cenital

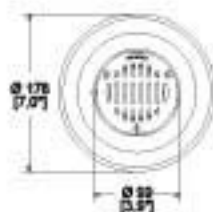

Dimensiones:
vista lateral

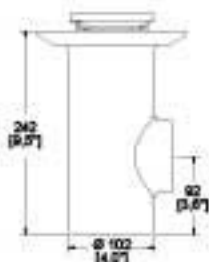

Sello hidráulico.
No permite el paso de malos olores.
Cuerpo de hierro fundido.



COLADERAS PARA PISO EN INTERIORES DE UNA BOCA

282-35-CHL

\$ 5.139.00

Coladera de una boca, desagüe de contorno cuadrado.



Dimensiones:
vista cenital

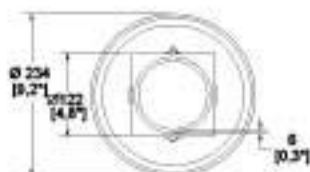

Dimensiones:
vista lateral

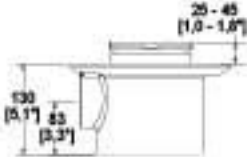

Sello hidráulico.
No permite el paso de malos olores.
Cuerpo de hierro fundido.

282-35-CHLI

\$ 5.139.00

Coladera de una boca, desagüe de contorno cuadrado para inserto cerámico máximo de 10 mm.



Dimensiones:
vista cenital

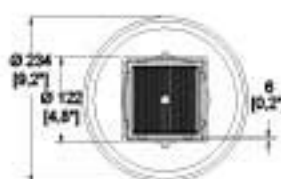

Dimensiones:
vista lateral



Sello hidráulico.
No permite el paso de malos olores.
Cuerpo de hierro fundido.

282-35CH

\$ 4.515.00

Coladera de una boca, rejilla cuadrada.



Dimensiones:
vista cenital

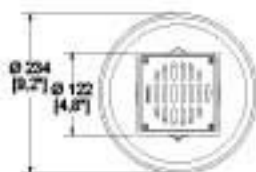

Dimensiones:
vista lateral

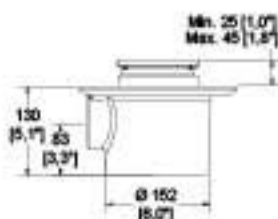

Sello hidráulico.
No permite el paso de malos olores.
Cuerpo de hierro fundido.

282-H

\$ 3.315.00

Coladera de una boca, rejilla redonda.



Dimensiones:
vista cenital



Dimensiones:
vista lateral

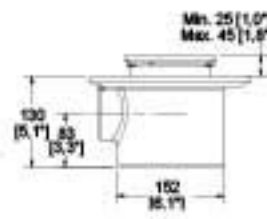

Sello hidráulico.
No permite el paso de malos olores.
Cuerpo de hierro fundido.

ÍNDICE ALFANUMÉRICO

MODELO	DESCRIPCIÓN	PRECIO	PÁGINA
TV-302-C	Líquida. Llave de lavabo electrónica de sensor. De corriente	\$ 16,379.00	194
TV302-C-15 < ECOLYDE	Líquida. Llave de lavabo electrónica de sensor. De corriente	\$ 16,379.00	194
TV-304	Forza. Llave de lavabo electrónica de sensor. De baterías alcalinas AA	\$ 14,221.00	195
TV304-15 < ECOLYDE	Forza. Llave de lavabo electrónica de sensor. De baterías alcalinas AA	\$ 14,221.00	195
TV-304-C	Forza. Llave de lavabo electrónica de sensor. De corriente	\$ 14,982.00	195
TV304-C-15 < ECOLYDE	Forza. Llave de lavabo electrónica de sensor. De corriente	\$ 14,982.00	195
TV-305	Llave de lavabo electrónica de sensor. De baterías alcalinas AA	\$ 12,087.00	195
TZF NAO < ECOLYDE	Taza para fluxómetro, elongada, trampa expuesta	\$ 5,165.00	236
TZF NAO P < ECOLYDE	Taza para fluxómetro a pared. Trampa semi oculta	\$ 5,580.00	238
TZF NAO17 < ECOLYDE	Taza para fluxómetro, elongada, trampa expuesta. Altura comfortable	\$ 5,165.00	236
V.D.1176	Válvula de drenaje antirretorno. Para tubo de albañal	\$ 9,143.00	181
V.D.1176-6	Válvula de drenaje antirretorno. Para tubo de PVC sanitario de 6"	\$ 9,143.00	181
VCG-2	Llave de hospital con cuello de ganso giratorio manija corta	\$ 4,040.00	185
VCG-2T	Llave de hospital con cuello de ganso giratorio. Maneral Tritón	\$ 4,040.00	185
VCG2-19 < ECOLYDE	Llave de hospital con cuello de ganso giratorio manija corta	\$ 4,040.00	185
WC AUSTRAL < ECOLYDE	Inodoro, taza y tanque elongado compacto. Trampa expuesta	\$ 3,969.00	230
WC AUSTRAL P < ECOLYDE	Inodoro, taza y tanque elongado compacto. Trampa expuesta	\$ 3,969.00	231
WC BOLMEN16 < ECOLYDE	Taza elongada y trampa oculta de altura comfortable	\$ 5,555.00	224
WC BOLMEN16 M < ECOLYDE	Taza elongada y trampa oculta de altura comfortable. Color marfil	\$ 5,555.00	224
WC DRAKAR < ECOLYDE	Inodoro, taza y tanque elongado. Trampa expuesta	\$ 4,545.00	227
WC DRAKAR M < ECOLYDE	Inodoro, taza y tanque elongado. Trampa expuesta. Color marfil	\$ 4,545.00	227
WC DRAKAR16 < ECOLYDE	Inodoro, taza y tanque elongado. Trampa expuesta	\$ 4,545.00	228
WC MIURA16 < ECOLYDE	Inodoro, taza y tanque Elongado. Trampa oculta	\$ 9,258.00	222
WC MIURA16 TCC < ECOLYDE	Inodoro, taza y tanque elongado. Tecnología Cero Contacto	\$ 13,357.00	221
WC MURANO < ECOLYDE	Inodoro, taza y tanque elongado. Trampa oculta	\$ 10,662.00	219
WC OLIMPIA < ECOLYDE	Inodoro, taza y tanque redondo. Trampa expuesta	\$ 4,055.00	226
WC OLIMPIA M < ECOLYDE	Inodoro, taza y tanque redondo. Trampa expuesta. Color marfil	\$ 4,055.00	226
WC OPTION < ECOLYDE	Inodoro, taza y tanque elongado compacto. Trampa expuesta	\$ 3,879.00	229
WC RÓDANO16 < ECOLYDE	Inodoro, taza y tanque elongado. Trampa expuesta	\$ 5,555.00	225
WC RÓDANO16 M < ECOLYDE	Inodoro, taza y tanque elongado. Trampa expuesta. Color marfil	\$ 5,555.00	225

COLADERAS PARA PISO EN INTERIORES DE UNA Y TRES BOCAS

282-HL

\$ 3.908.00

Coladera redonda de una boca, desagüe de contorno.



Dimensiones:
vista cenital



Dimensiones:
vista lateral

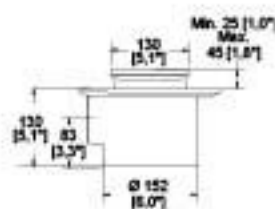

Sello hidráulico.
No permite el paso de malos olores.
Cuerpo de hierro fundido.

282-HLI

\$ 3.908.00

Coladera de una boca, desagüe de contorno redondo para inserto cerámico máximo de 10 mm.



Dimensiones:
vista cenital

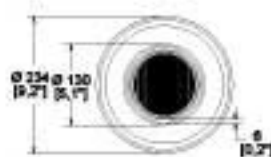

Dimensiones:
vista lateral



Sello hidráulico.
No permite el paso de malos olores.
Cuerpo de hierro fundido.

25

\$ 1.972.00

Coladera de tres bocas, rejilla redonda.



Dimensiones:
vista cenital

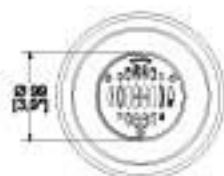

Dimensiones:
vista lateral

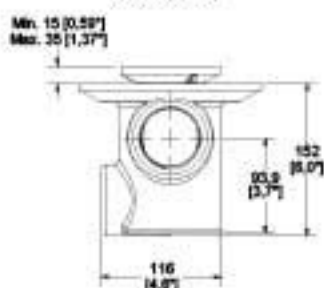

Sello hidráulico.
No permite el paso de malos olores.
Cuerpo de hierro fundido.

25-CH

\$ 2.128.00

Coladera de tres bocas, rejilla cuadrada.



Dimensiones:
vista cenital

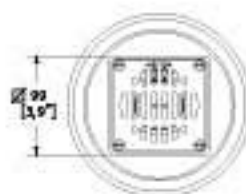

Dimensiones:
vista lateral

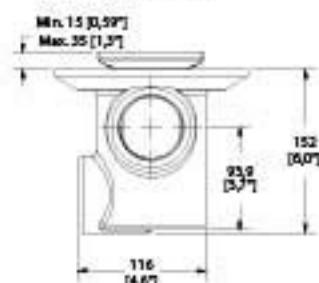

Sello hidráulico.
No permite el paso de malos olores.
Cuerpo de hierro fundido.

COLADERAS PARA PISO EN INTERIORES DE TRES BOCAS

25-CHL

\$ 2.442.00

Coladera de tres bocas, desagüe de contorno cuadrado.



Dimensiones:
vista cenital



Dimensiones:
vista lateral

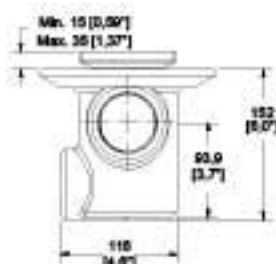

Sello hidráulico.
No permite el paso de malos olores.
Cuerpo de hierro fundido.

25-CHLI

\$ 2.442.00

Coladera cuadrada de tres bocas, desagüe de contorno para inserto cerámico máximo de 10 mm.



Dimensiones:
vista cenital

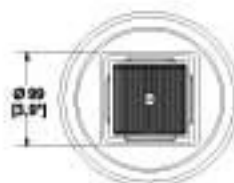

Dimensiones:
vista lateral

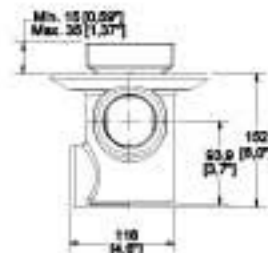

Sello hidráulico.
No permite el paso de malos olores.
Cuerpo de hierro fundido.

25-HL

\$ 2.282.00

Coladera de tres bocas, desagüe de contorno rejilla redonda.



Dimensiones:
vista cenital

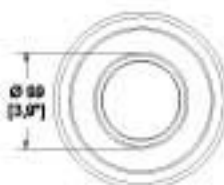

Dimensiones:
vista lateral



Sello hidráulico.
No permite el paso de malos olores.
Cuerpo de hierro fundido.

25-HLI

\$ 2.282.00

Coladera de tres bocas, desagüe de contorno redondo para inserto cerámico máximo de 10 mm.



Dimensiones:
vista cenital

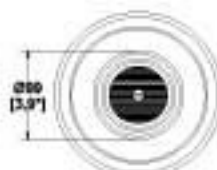

Dimensiones:
vista lateral

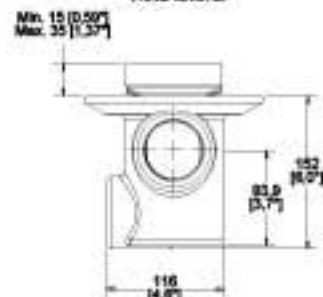

Sello hidráulico.
No permite el paso de malos olores.
Cuerpo de hierro fundido.

26

\$ 2.032.00

Coladera de tres bocas, con tapa ciega redonda.



Dimensiones:
vista cenital



Dimensiones:
vista lateral



Sello hidráulico.
No permite el paso de malos olores.
Cuerpo de hierro fundido.

28

\$ 2.472.00

Coladera alta de tres bocas, rejilla redonda de 25 cm.



Dimensiones:
vista cenital

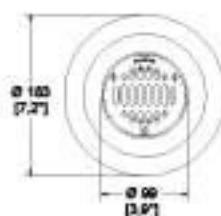

Dimensiones:
vista lateral

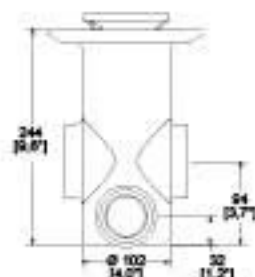

Sello hidráulico.
No permite el paso de malos olores.
Cuerpo de hierro fundido.

1342-35-CHL

\$ 4.408.00

Coladera de tres bocas, desagüe de contorno cuadrado.



Dimensiones:
vista cenital

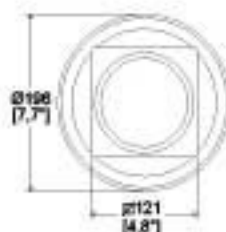

Dimensiones:
vista lateral

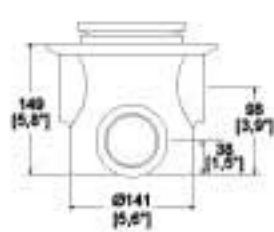

Sello hidráulico.
No permite el paso de malos olores.
Cuerpo de hierro fundido.

1342-35-CHLI

\$ 4.408.00

Coladera de tres bocas, desagüe de contorno cuadrado para inserto cerámico máximo de 10 mm.



Dimensiones:
vista cenital

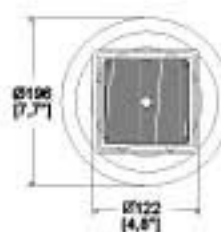

Dimensiones:
vista lateral

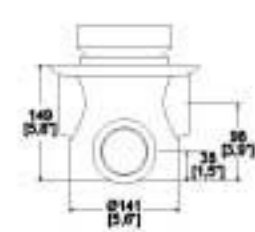

Sello hidráulico.
No permite el paso de malos olores.
Cuerpo de hierro fundido.

COLADERAS PARA PISO EN INTERIORES DE TRES BOCAS

1342-35CH

\$ 3.800.00

Coladera de tres bocas,
rejilla cuadrada.



Dimensiones:
vista cenital

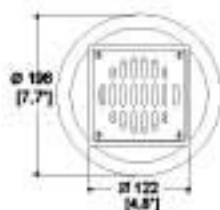

Dimensiones:
vista lateral

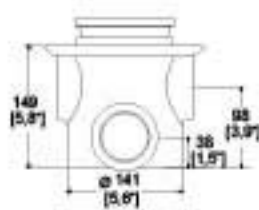

Sello hidráulico.
No permite el paso de malos olores.
Cuerpo de hierro fundido.

1342-H

\$ 2.822.00

Coladera de tres bocas,
rejilla redonda.



Dimensiones:
vista cenital

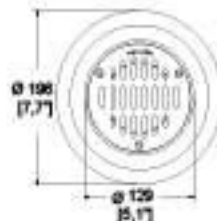

Dimensiones:
vista lateral

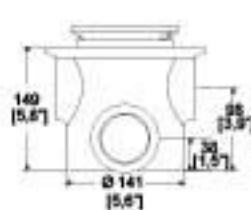

Sello hidráulico.
No permite el paso de malos olores.
Cuerpo de hierro fundido.

1342-HL

\$ 3.409.00

Coladera de tres bocas,
desagüe de contorno
redondo.



Dimensiones:
vista cenital

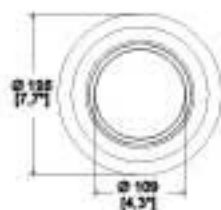

Dimensiones:
vista lateral

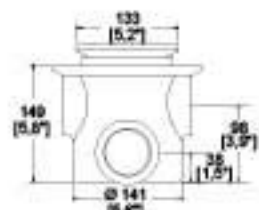

Sello hidráulico.
No permite el paso de malos olores.
Cuerpo de hierro fundido.

1342-HLI

\$ 3.409.00

Coladera de tres bocas,
desagüe de contorno
redondo para inserto
cerámico máximo
de 10 mm.



Dimensiones:
vista cenital

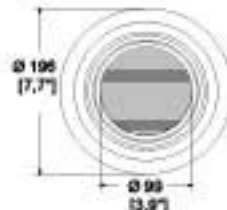

Dimensiones:
vista lateral

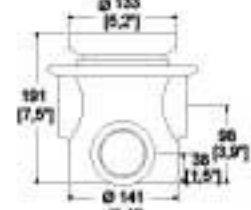

Sello hidráulico.
No permite el paso de malos olores.
Cuerpo de hierro fundido.

2514

\$ 2.902.00

Coladera de rejilla redonda con campana. Conexión para tubo de 102 mm (4") de roscar. Con gran capacidad de drenado. Tránsito pesado. Sello hidráulico.



Dimensiones:
vista cenital



Dimensiones:
vista lateral

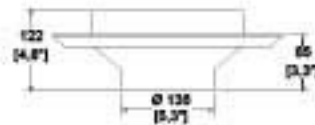

Para patios, garages, terrazas, etc.
Cuerpo de hierro fundido.

2584

\$ 8.436.00

Coladera de rejilla cuadrada, de acero inoxidable con campana. Conexión para tubo de 102 mm (4") de roscar. Sello hidráulico.



Dimensiones:
vista cenital

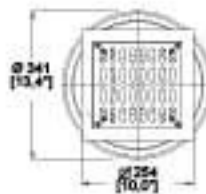

Dimensiones:
vista lateral

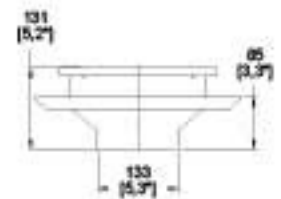

Exteriores y/o interiores.
Cuerpo de hierro fundido.

2714

\$ 6.959.00

Coladera de rejilla rectangular con campana. Conexión para tubo de 102 mm (4") de roscar. Con gran capacidad de drenado. Sello hidráulico.



Dimensiones:
vista cenital

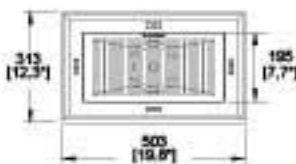

Dimensiones:
vista lateral

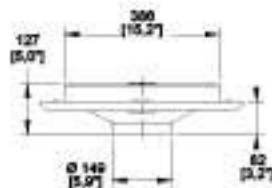

Para patios, garages, terrazas, etc.
Cuerpo de hierro fundido.

5424

\$ 3.195.00

Coladera de rejilla redonda, con canastilla para sedimentos. Conexión para tubo de 102 mm (4") de roscar. Para terrazas, plantas industriales, fábricas, tránsito pesado.



Dimensiones:
vista cenital



Dimensiones:
vista lateral

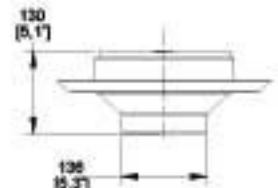

Usos: Para jardines o terrazas con plantas.
Cuerpo de hierro fundido.

COLADERAS PARA AZOTEA

4954

\$ 2.850.00

Coladera de pretil para azotea.
Conexión para tubo 102 mm (4") de roscar.



Dimensiones:
vista frontal



Dimensiones:
vista lateral

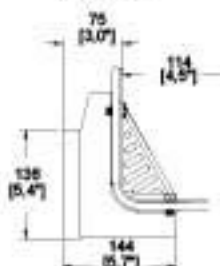

Cuerpo de hierro fundido.

444

\$ 1.888.00

Coladera de cúpula para azotea.
Conexión para tubo 102 mm (4") de roscar.



Dimensiones:
vista cenital



Dimensiones:
vista lateral

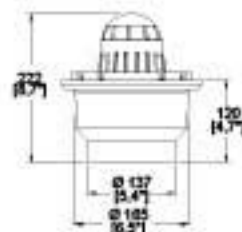

Cuerpo de hierro fundido.

444-X

\$ 1.888.00

Coladera de cúpula para azotea.
Conexión para tubo 102 mm (4") de retacar.



Dimensiones:
vista cenital



Dimensiones:
vista lateral

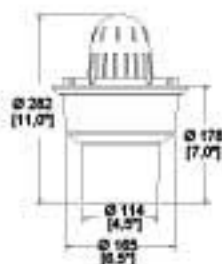

Cuerpo de hierro fundido.

446-X

\$ 3.837.00

Coladera de cúpula para azotea.
Conexión para tubo 153 mm (6") de retacar.



Dimensiones:
vista cenital



Dimensiones:
vista lateral

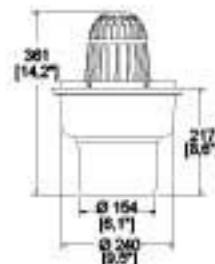

Cuerpo de hierro fundido.

342-C

Acero inoxidable

\$ 1.168.00

Rebosadero de rejilla cuadrada. Conexión para tubo 51 mm (2") de retacar.



Dimensiones:
vista cenital

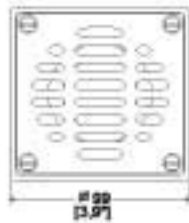

Dimensiones:
vista lateral

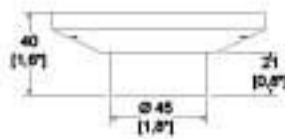

Cuerpo de latón forjado y rejilla de acero inoxidable.



AI

342-CL

\$ 1.340.00

Rebosadero con desagüe de contorno cuadrado. Conexión para tubo 51 mm (2") de retacar.



Dimensiones:
vista cenital

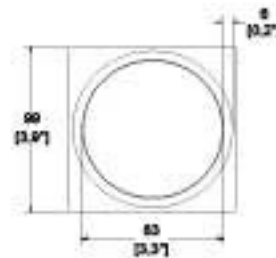

Dimensiones:
vista lateral

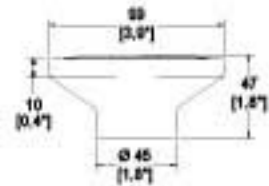

Contra de latón forjado y cúpula de latón.

342-R

Acero inoxidable

\$ 997.00

Rebosadero de rejilla redonda. Conexión para tubo 51 mm (2") de retacar.



Dimensiones:
vista cenital



Dimensiones:
vista lateral

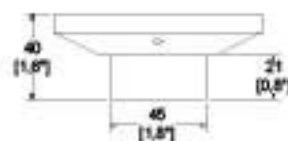

Cuerpo de latón forjado y rejilla de acero inoxidable.



AI

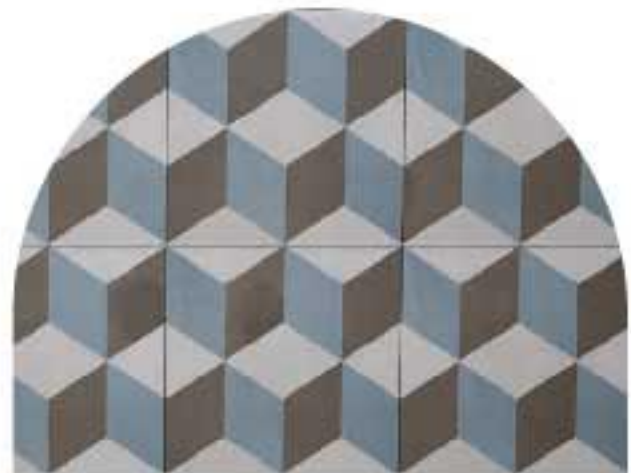

REBOSADEROS

342-RL

\$ 1.139.00

Rebosadero con desagüe de contorno redondo. Conexión para tubo 51 mm (2") de retacar.



Dimensiones:
vista cenital

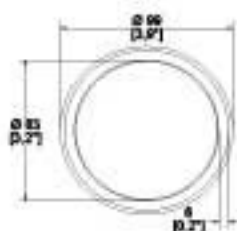

Dimensiones:
vista lateral

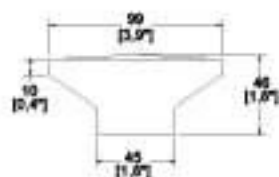

Contra de latón forjado y cúpula de latón.

632-H

Acero inoxidable

\$ 2.625.00

Rebosadero de rejilla rectangular de acero inoxidable. Conexión para tubo 51 mm (2") de roscar.



Dimensiones:
vista cenital



Dimensiones:
vista lateral

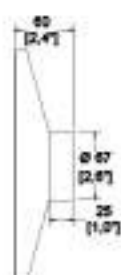

Usos: Para pasillos o alberca.
Cuerpo de latón y rejilla de acero inoxidable.



AI

IG-20

\$ 20.701.00

Interceptor de grasa con canastilla para sedimentos sólidos de 45 L/min y 18 kg de capacidad. Conexión para tubo de 2" de roscar.



Dimensiones:
vista cenital

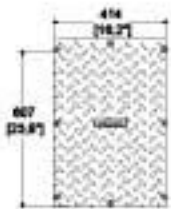

Dimensiones:
vista lateral



Puede colocarse de manera expuesta o soterrada.

IG-40

\$ 35.863.00

Interceptor de grasa con canastilla para sedimentos sólidos de 90 L/min y 36 kg de capacidad. Conexión para tubo de 4" de roscar.



Dimensiones:
vista cenital

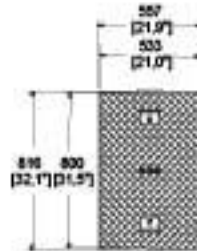

Dimensiones:
vista lateral



Puede colocarse de manera expuesta o soterrada.

IG-20-PTM

\$ 16.325.00

Interceptor de grasa de polietileno con tapa metálica y canastilla para sedimentos sólidos de 45 L/min y 18 kg de capacidad. Conexión para tubo de 2" de roscar.



Dimensiones:
vista cenital

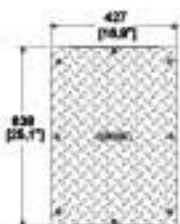

Dimensiones:
vista lateral

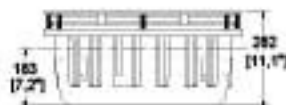

VÁLVULAS PARA DRENAJE

V.D.1176

\$ 9.143.00

Válvula de drenaje antirretorno.
Para tubo de albañal.
Compuerta de latón.



Dimensiones:
vista cenital

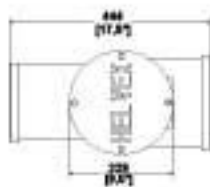

Dimensiones:
vista lateral



Se instala con una inclinación de 1 cm por metro lineal.

V.D.1176-6

\$ 9.143.00

Válvula de drenaje antirretorno.
Para tubo de PVC sanitario de 6".
Compuerta de latón.



Dimensiones:
vista cenital

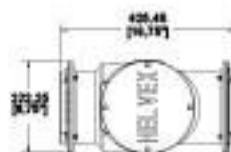

Dimensiones:
vista lateral

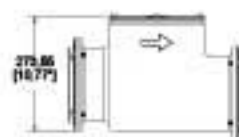

Se instala con una inclinación de 1 cm por metro lineal.

ACABADOS



CR

Cromo



EB

Ébano

ACABADOS



CR
Cromo

LLAVES PARA HOSPITAL



Mezcladoras con cuello de ganso.



Llaves electrónicas a pared. *







Llaves unitarias con cuello de ganso.

Hospitales importantes en donde se han especificado nuestros productos:

- Hospital Angeles Acoxta
- Hospital Angeles Interlomas
- Hospital Dalinde San Ángel
- Hospital Angeles Pedregal
- Hospital Dalinde Tuxpan
- Hospital ISSEMYM Toluca
- Hospital ISSEMYM Talnepantla
- Hospital ISSEMYM Zumpango
- Hospital Médica Sur
- Clínica ISSSTE Zona 1 Marina Nacional
- Clínica ISSSTE Zona 1 San Antonio Abad

★ NOM-001-SCFI-2018

"Aparatos electrónicos - Requisitos de seguridad y Métodos de Prueba".

Visite nuestra página web para consultar y descargar fichas técnicas e instructivos de instalación.
helvex.com    



LLAVES PARA HOSPITAL



MODELOS AHORRADORES DISPONIBLES



ECOLVEX

Productos con uso
eficiente de agua.

NMX

NMX-C-415-0HNCC-2015 "Industria de la
Construcción - Válvulas y Grifos para
Agua - Especificaciones y Métodos de ensayo".

*Sólo aplica con productos Ecolvex:
H13341G-1.9 y VCG2-1.9

Llaves con sensor electrónico
de baterías o corriente a pared.

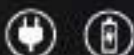

Llaves con cuello
de ganso giratorio.



Cuello
giratorio.

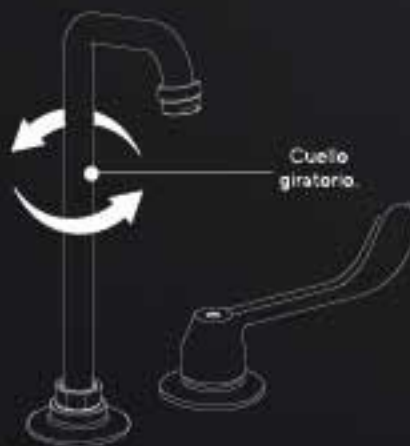

Mezcladora de manijas largas.



HELVEX

Garantía de Calidad



Garantía Helvex en acabado cromo de 10 años
y resto de acabados 2 años.

LLAVES DE LAVABO ELECTRÓNICAS DE SENSOR A PARED

TV-201

Cromo



De baterías
alcalinas AA

\$ 15,545.00



Modelo ahorrador
TV201-1.9

TV-201-C

Cromo



De corriente

\$ 16,379.00



Modelo ahorrador
TV201-C-1.9



Cuello giratorio.
Presión mínima requerida 0.40 kg/cm².

CR

Dimensiones:
vista frontal

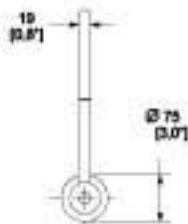

Dimensiones:
vista lateral

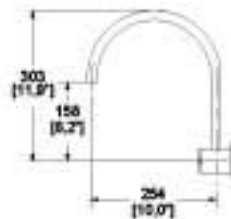

NOM

NOM-001-SCFI-2018





TV-203

Cromo



De baterías
alcalinas AA

\$ 15,545.00



Modelo ahorrador
TV203-19

TV-203-C

Cromo



De corriente

\$ 16,379.00



Modelo ahorrador
TV203-C-19



Cuello giratorio,
Presión mínima requerida 0.40 kg/cm².



Dimensiones:
vista frontal

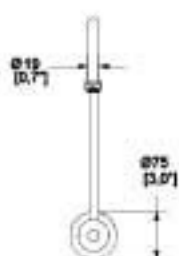

Dimensiones:
vista lateral

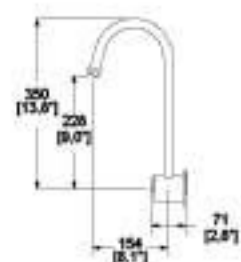

NOM NOM-001-SCFI-2018

LLAVES DE HOSPITAL

VCG-2

Cromo

\$ 4,040.00

Llave de hospital con cuello de ganso giratorio manija corta.



Dimensiones:
vista frontal



Dimensiones:
vista lateral

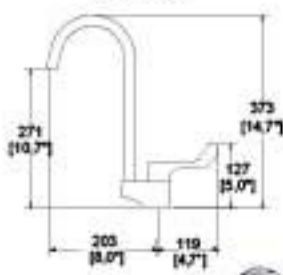

Cuello giratorio.
Presión mínima requerida 0.25 kg/cm².

NMX NMX-C-415-ONNCCCE-2015

CR

VCG-2T

Cromo

\$ 4,040.00

Llave de hospital con cuello de ganso giratorio. Maneral Tritón.

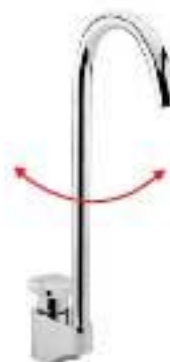

Dimensiones:
vista frontal



Dimensiones:
vista lateral

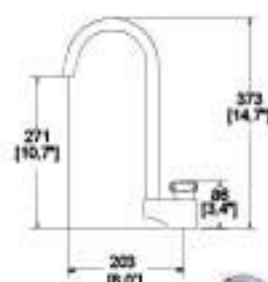

Cuello giratorio.
Presión mínima requerida 0.25 kg/cm².

CR



H-13341G

Cromo

\$ 7,225.00

Mezcladora de hospital 8" a 12" con cuello de ganso giratorio y manijas largas. No incluye contra.



Dimensiones:
vista frontal

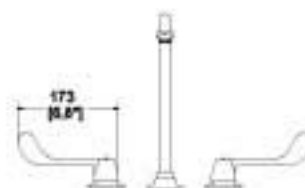

Dimensiones:
vista lateral

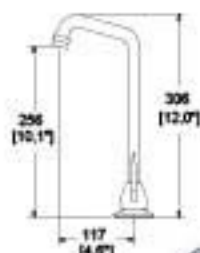

Incluye manerales.
Cuello giratorio.
Presión mínima requerida 0.25 kg/cm².

NMX NMX-C-415-ONNCCCE-2015

CR

ACABADOS



CR
Cromo

LLAVES ECONOMIZADORAS



Llaves economizadoras de válvula.



Llaves temporizadoras con botón de push.







A piso y a pared.

Todas nuestras llaves economizadoras son productos ahorradores con los que Helvex favorece la edificación sustentable, optimizando y midiendo las acciones para salvaguardar los recursos naturales con un consumo máximo desde 1.9 hasta 5 litros por minuto.

Tecnología innovadora

- Llaves economizadoras que por su mecanismo evitan el desperdicio de agua.
- Las llaves temporizadoras, cuentan con un mecanismo de tiempo de activación programado, que evita el desperdicio de agua.

Visite nuestra página web para consultar y descargar fichas técnicas e instructivos de instalación.
helvex.com    



LLAVES ECONOMIZADORAS



FÁCIL
ACCIONAMIENTO

LLAVES A PARED



RECUBRIMIENTO
ANTIBACTERIAL
EN SISTEMA PUSH



RECUBRIMIENTO
ANTIBACTERIAL
EN LA PERILLA



Productos con uso
eficiente de agua

NMX

NMX-C-415-DNCCCE-2015 "Industria de la
Construcción - Válvulas y Grifos para
Agua - Especificaciones y Métodos de ensayo".

*Sólo aplica con productos Ecolvex:
TV105-2, TV122-1.9 y TV121-1.9



Garantía Helvex en
acabado cromo de 10 años
y resto de acabados 2 años.

HELVEX

Garantía de Calidad

**AHORRA EN PROMEDIO 5,986 LITROS
DE AGUA AL AÑO POR LLAVE**

Los datos son comparados con el flujo máximo permitido por la NOM.

LLAVES ECONOMIZADORAS Y TEMPORIZADORAS

TV-100

Cromo

\$ 3.874.00

Llave de lavabo economizadora a pared.



Dimensiones:
vista frontal

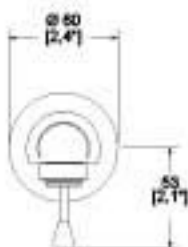

Dimensiones:
vista lateral

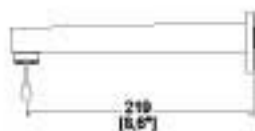

Seguro antirrobo.
Presión mínima requerida 0.25 kg/cm².
Consumo de agua: 5 L/min.
Perilla con recubrimiento antibacterial.



CR



TV-105

Cromo

\$ 3.692.00

Llave de lavabo economizadora.



Modelo ahorrador
TV105-2

Dimensiones:
vista frontal

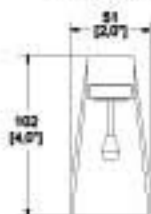

Dimensiones:
vista lateral

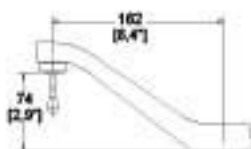

Seguro antirrobo.
Presión mínima requerida 0.20 kg/cm².
Consumo de agua: 5 L/min.
Perilla con recubrimiento antibacterial.



CR



NMX NMX-C-415-ONNCCE-2015



MANERALES



Redondos.



Cuadrados.







Cruceles.



Palanca.



Visite nuestra página web para consultar y descargar
fichas técnicas e instructivos de instalación.
helvex.com    

STALA

TV-106

Cromo

\$ 3.479.00

Llave de lavabo economizadora.



Dimensiones:
vista frontal

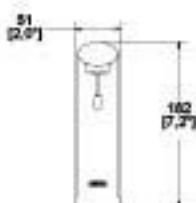

Dimensiones:
vista lateral

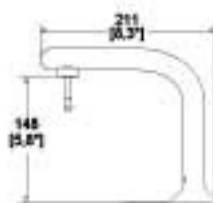

Presión mínima requerida 0.25 kg/cm².
Consumo de agua: 3 L/min.

Perilla con recubrimiento antibacterial.



CR

TV-121

Cromo

\$ 4.452.00

Llave de lavabo temporizadora a pared.



Dimensiones:
vista frontal

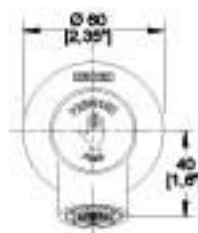

Dimensiones:
vista lateral

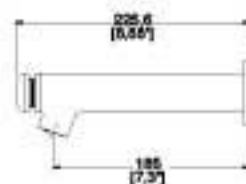

Cierre automático.

Presión mínima requerida 0.25 kg/cm².

Consumo de agua: 8.3 L/min.

Botón con recubrimiento antibacterial.



CR

TV-122

Cromo

\$ 4.245.00

Llave de lavabo temporizadora a piso.



Dimensiones:
vista frontal

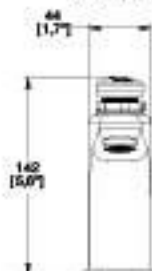

Dimensiones:
vista lateral

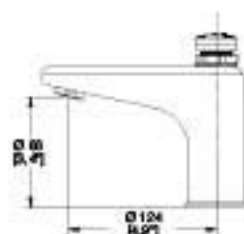

Cierre automático.

Presión mínima requerida 0.25 kg/cm².

Consumo de agua: 8.3 L/min

Botón con recubrimiento antibacterial.



CR

NMX NMX-C-415-0NMCCE-2015





ACABADOS



CR
Cromo



B
Polar

LLAVES ELECTRÓNICAS



Llaves electrónicas de sensor.

- Máxima higiene (sistema electrónico que detecta la presencia del usuario).
- Ahorro significativo de agua (proporciona la cantidad necesaria para una limpieza completa).



Llaves electrónicas de proximidad.

- Sin sensores aparentes (la presencia del usuario cierra el circuito electrónico de la llave).
- Garantizan un óptimo consumo de agua.
- Mayor eficiencia energética.



Llaves electrónicas de proximidad a pared.

Tecnologías innovadoras y certificaciones:

Llaves electrónicas que cuentan con un tiempo de activación programado para evitar el desperdicio de agua.



Llaves electrónicas de proximidad que se activan al acercar las manos alrededor de la llave y se cierra al retirar las manos.

NOM

Todas nuestras llaves electrónicas cumplen con la Norma Oficial Mexicana NOM-001-SCFI-2018 "Aparatos electrónicos - Requisitos de seguridad y Métodos de Prueba".



LLAVES ELECTRÓNICAS



LLAVES ELECTRÓNICAS DE SENSOR A PARED

- Sensor infrarrojo.
- Distancia de detección 12 cm.
- Cuentan con un tiempo de activación programado para evitar el desperdicio de agua.



LLAVES ELECTRÓNICAS DE PROXIMIDAD

- Sin sensores aparentes.
- Se activan al acercar las manos alrededor de la llave y se cierra al retirar las manos.

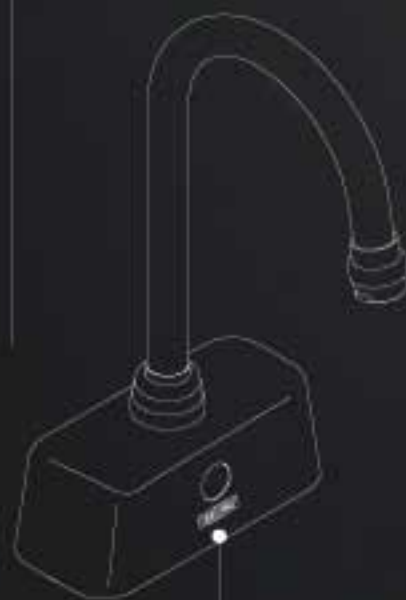

LLAVES ELECTRÓNICAS DE SENSOR

- Máxima higiene (sistema electrónico que detecta la presencia del usuario).
- Ahorro significativo de agua (proporciona la cantidad necesaria para una limpieza completa).

HELVEX

Garantía de Calidad



Productos con uso
eficiente de agua



Garantía Helvex en acabado cromo de 10 años
y resto de acabados 2 años.

LLAVES DE LAVABO ELECTRÓNICAS

NIMBUS

TV-190

Cromo



\$ 16,145.00

Llave de lavabo electrónica de proximidad.



De baterías de litio 6V



Dimensiones:
vista frontal

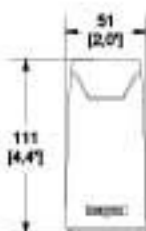

Dimensiones:
vista lateral

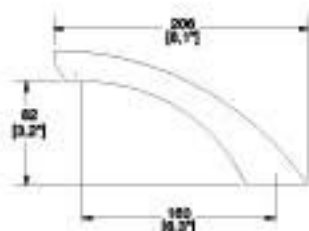

Tecnología de proximidad.
Presión mínima requerida 0.60 kg/cm².



CR

LLAVE DE LAVABO ELECTRÓNICA DE SENSOR A PARED

NUVA

TV-200

Cromo



De baterías alcalinas AA

\$ 15,545.00

NUVA

TV-200-C

Cromo



De corriente

\$ 16,379.00



Presión mínima requerida 0.40 kg/cm².



CR

Dimensiones:
vista frontal

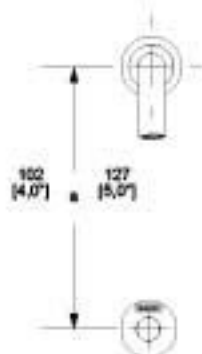

Dimensiones:
vista lateral

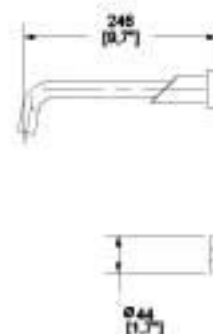

NOM NOM-001-SCFI-2018

Los precios Incluyen IVA

191

HELVEX
Garantía de Calidad

LLAVES DE LAVABO ELECTRÓNICAS DE SENSOR

ARGOS

TV-296

Cromo



\$ 15,545.00



ARGOS

TV-296-C

Cromo

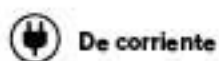

\$ 16,379.00



Presión mínima requerida 0.40 kg/cm².

CR

Dimensiones:
vista frontal



Dimensiones:
vista lateral

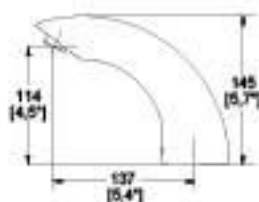

ALFA

TV-297

Cromo



\$ 15,545.00



ALFA

TV-297-C

Cromo



\$ 16,379.00



Presión mínima requerida 0.40 kg/cm².

CR

Dimensiones:
vista frontal



Dimensiones:
vista lateral

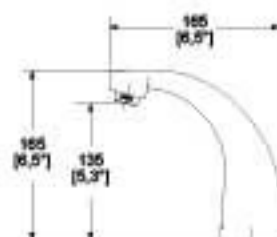

NOM NOM-001-SCFI-2018

LLAVES DE LAVABO ELECTRÓNICAS DE SENSOR

OMEGA

TV-298

Cromo



De baterías
alcalinas AA

\$ 15,545.00



Modelo ahorrador
TV 298-1.9



OMEGA

TV-298-C

Cromo



De corriente

\$ 16,379.00



Modelo ahorrador
TV298-C-1.9



Presión mínima requerida 0.40 kg/cm².

CR

Dimensiones:
vista frontal

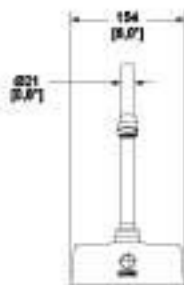

Dimensiones:
vista lateral

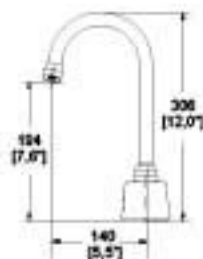

NOM NOM-001-SCFI-2018

LLAVES DE LAVABO ELECTRÓNICAS DE SENSOR CON AIREADOR OCULTO



LIQUIDA

TV-302

Cromo



De baterías
alcalinas AA

\$ 15,545.00



Modelo ahorrador
TV302-1.5

LIQUIDA

TV-302-C

Cromo



De corriente

\$ 16,379.00



Modelo ahorrador
TV302-C-1.5



LIQUIDA

TV-302-B

Polar



De baterías
alcalinas AA

\$ 17,877.00



Presión mínima requerida 0.80 kg/cm².

Dimensiones:
vista frontal

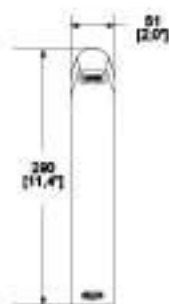

Dimensiones:
vista lateral

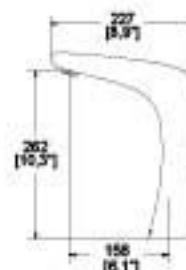

NOM NOM-001-SCFI-2018

LLAVES DE LAVABO ELECTRÓNICAS DE SENSOR

FORZA

TV-304
Cromo



De baterías
alcalinas AA

\$ 14,221.00



Modelo ahorrador
TV304-1.5



FORZA

TV-304-C
Cromo



De corriente

\$ 14,982.00



Modelo ahorrador
TV304-C-1.5



Presión mínima requerida 0.80 kg/cm².

CR

Dimensiones:
vista frontal

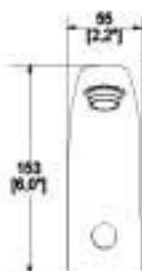

Dimensiones:
vista lateral

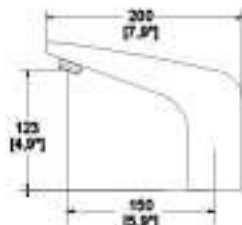

NOM-001-SCFI-2018

TV-305

Cromo

\$ 12,087.00



De baterías
alcalinas AA



Dimensiones:
vista frontal

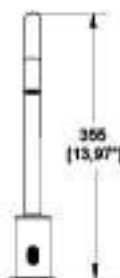

Dimensiones:
vista lateral

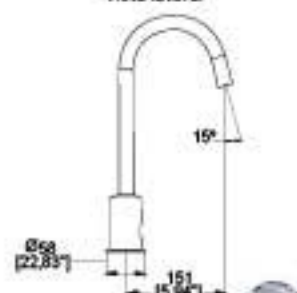

Cuello de ganso giratorio.
Presión mínima requerida 0.50 kg/cm².

CR





HELVEX

Garantía de Calidad







Garantía Helvex en acabado cromo de 10 años
y resto de acabados 2 años.





ACONDICIONADOR DE **AGUAS DURAS**



Visite nuestra página web para consultar y descargar
fichas técnicas e instructivos de instalación.
helvex.com    



ACONDICIONADOR DE AGUAS DURAS

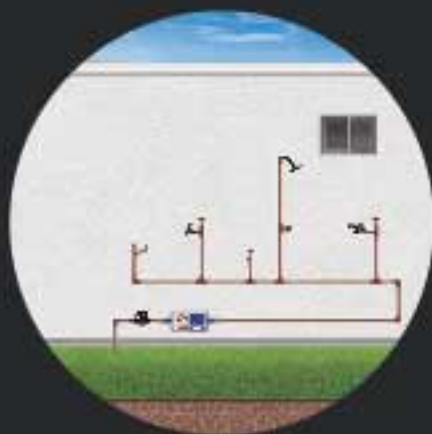

En un sistema directo sin sarro se coloca saliendo del medidor.

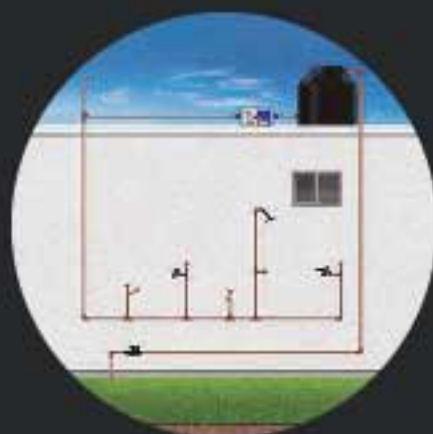

En un sistema de gravedad con tinaco, el sistema se coloca a la salida del tinaco.

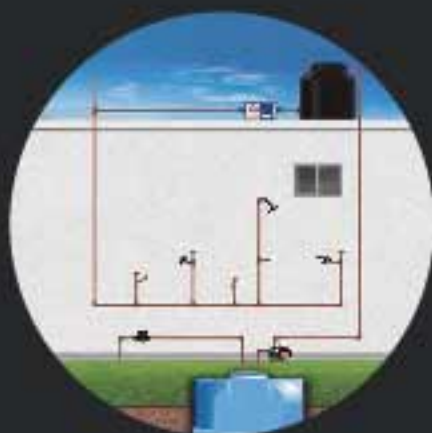

En un sistema de gravedad con tinaco y sistema se coloca a la salida del tinaco.



En un sistema asistido con hidroneumático o presurizador es conveniente colocar el sistema a la salida de la bomba presurizadora.

HELVEX

Garantía de Calidad



SS-1
Blanco

\$ 7.781.00



Acondicionador
de aguas duras.
De corriente Sinsarro.

Dimensiones:
vista frontal

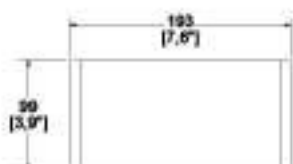

Dimensiones:
vista lateral



¿COMO FUNCIONA NUESTRO SISTEMA DE TRATAMIENTO DEL AGUA HELVEX?

A base de impulsos electrónicos que remueven, protegen e impiden la acumulación de cal y óxido en las tuberías.

BENEFICIOS

- **IMPIDE** nuevas acumulaciones.
- **NO** altera la **CALIDAD DEL AGUA**.
- **AHORRO** de hasta un 50% en el consumo de jabones, detergentes y shampoos.
- Evita la **ACUMULACIÓN DE MANCHAS DE SARRO** en llaves, muebles de baño, tinas, cortinas y cancelos.
- Se instala **DIRECTAMENTE EN LA TUBERÍA** de alimentación de agua, después del contador y antes de que se ramifique la tubería en el calentador u otra instalación hidráulica.
- Para uso **RESIDENCIAL** y **COMERCIAL**.

NOM NOM-001-SCFI-2018

Los precios Incluyen IVA

197

HELVEX
Gobierno de Calidad

ACABADOS



CR
Cromo



AC
Acero
Pulido



B
Blanco



AL
Aluminio



AI
Acero
Inoxidable



S/AI
Satin/Acero
inoxidable

ACCESORIOS INSTITUCIONALES



Secadores de manos.

- Ahorro en el consumo de papel toalla.
- Nivel de ruido de 65 decibeles equivalente al sonido de un restaurant (ningún daño auditivo), muy bajo comparado con otros (90 decibeles, equivalente al ruido de una máquina para cortar césped, posible daño auditivo con exposición prolongada).
- Menor consumo de energía (tiempo de secado de 10 a 15 segundos).
- Sistema de apagado automático que evita quemaduras.
- Certificados de conformidad con la NOM-003-SCFI-2014 "Productos eléctricos - Especificaciones de seguridad".



Barras de seguridad.

- Diámetro para una adecuada sujeción del usuario.
- Distancia a la pared que evita el deslizamiento de la mano hacia adentro.
- Acero inoxidable tipo 304 calibre 18.
- Soportan un peso estático de hasta 136 kg. por un periodo de 5 minutos con una recuperación total.
- Utilizadas en el 80% de los hoteles en México.







Dosificadores de jabón.

- Producto higiénico operado por un sensor electrónico.
- Contenedor rellenable que evita la compra de consumibles como cartuchos.
- Funciona con cualquier tipo y densidad de jabón líquido o gel antibacterial.
- Certificados de conformidad con la NOM-001-SCFI-2018 "Aparatos electrónicos - Requisitos de seguridad y Métodos de Prueba".



Diversidad de accesorios para baños institucionales.

- Agarradera para tina.
- Portapapel antirrobo.
- Repisa.
- Destapador.
- Tendadero retráctil.
- Gancho portamuletas.

Visite nuestra página web para consultar y descargar fichas técnicas e instructivos de instalación.
helvex.com    



ACCESORIOS INSTITUCIONALES



SECADORES DE MANOS

- Ahorro en el consumo de papel toalla.
- Nivel de ruido de 65 decibeles.
- Menor consumo de energía.
(tiempo de secado de 10 a 15 segundos).
- Sistema de apagado automático.



DOSIFICADORES DE JABÓN

- Producto higiénico operado por un sensor electrónico.
- Contenedor rellenable.
- Funciona con cualquier tipo de jabón líquido.



Superficie antiderrapante
(BR-470)

BARRAS DE SEGURIDAD

- Diámetro para una adecuada sujeción del usuario.
- Soportan un peso estático de hasta 136 kg. por un período de 5 minutos con una recuperación total.
- FABRICADAS DE ACERO INOXIDABLE.

HELVEX

Garantía de Calidad

17

Cromo

\$1.486.00

Portapapel con repisa para celular.



Dimensiones:
vista frontal



Dimensiones:
vista cenital

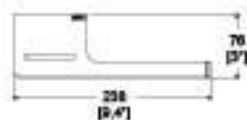

Acabado.



CR



B-305-S

Acero inoxidable

\$ 1.860.00

Barra recta de seguridad
305 mm Al.



Dimensiones:
vista frontal



Dimensiones:
vista lateral

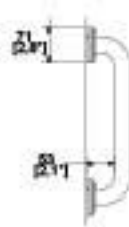

Carga máxima aplicada 136 kg máximo,
por un periodo de 5 minutos.



AI

B-470-S

Acero inoxidable

\$ 1.860.00

Barra recta de seguridad
470 mm Al.



Dimensiones:
vista frontal



Dimensiones:
vista lateral



Carga máxima aplicada 136 kg máximo,
por un periodo de 5 minutos.



AI

B-610-S

Acero inoxidable

\$ 1.971.00

Barra recta de seguridad
610 mm Al.



Dimensiones:
vista frontal



Dimensiones:
vista lateral



Carga máxima aplicada 136 kg máximo,
por un periodo de 5 minutos.



AI

B-700-S

Acero inoxidable

\$ 2.021.00

Barra recta de seguridad
700 mm Al.



Dimensiones:
vista frontal



Dimensiones:
vista lateral



Carga máxima aplicada 136 kg máximo,
por un periodo de 5 minutos.



AI



MANERALES

FLAIR

C-5

Acrílico transparente

\$ 1.371.00

Juego de manerales grandes.



Dimensiones
vista frontal

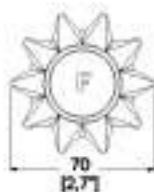

Dimensiones
vista lateral

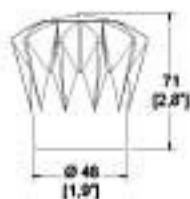

Cuerpo de latón.
Acrílico transparente.

TRITÓN

C-12

Cromo

\$ 1.390.00

Juego de manerales grandes.



Dimensiones:
vista frontal

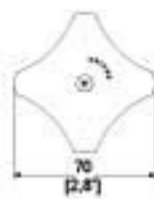

Dimensiones:
vista lateral

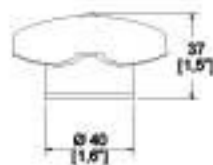

Acabado.



CAPRI

C-14

Cromo

\$ 1.551.00

Juego de manerales grandes.



Dimensiones
vista frontal

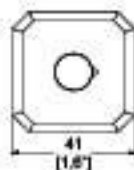

Dimensiones
vista lateral

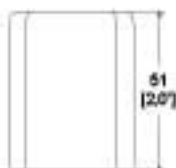

Acabado.



RIVOLI

C-16

Cromo

\$ 1.551.00

Juego de manerales grandes.



Dimensiones:
vista frontal

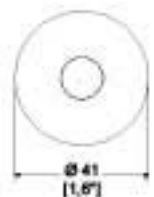

Dimensiones:
vista lateral



Acabado.



B-062-S

Acero inoxidable

\$ 4.223.00

Barra angular Hockey
810 mm x 350 mm
derecha AI.



Dimensiones:
vista frontal

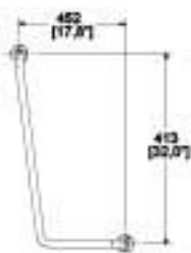

Dimensiones:
vista lateral

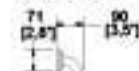

Carga máxima aplicada 136 kg máximo,
por un periodo de 5 minutos.

B-064-S

Acero inoxidable

\$ 4.223.00

Barra angular Hockey
810 mm x 350 mm
izquierda AI.



Dimensiones:
vista frontal

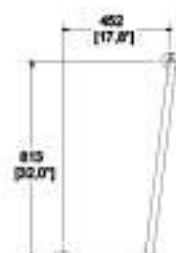

Dimensiones:
vista lateral

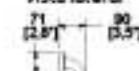

Carga máxima aplicada 136 kg máximo,
por un periodo de 5 minutos.

B-066-S

Acero inoxidable

\$ 3.167.00

Barra angular Boomerang
305 mm x 305 mm
izquierda AI.



Dimensiones:
vista frontal

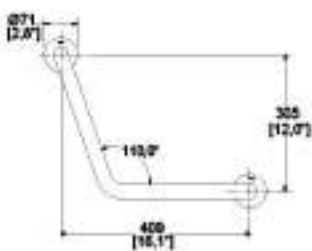

Dimensiones:
vista lateral



Carga máxima aplicada 136 kg máximo,
por un periodo de 5 minutos.

BR-470

Cromo

\$ 3.099.00

Barra de seguridad
residencial
antiderrapante.



Dimensiones:
vista frontal

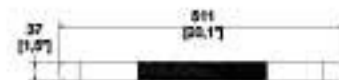

Dimensiones:
vista cenital

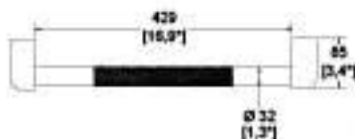

Resistencia de carga: 100 kg en muro de concreto.

SECADORES DE MANOS

MB-1011

Blanco

\$ 9,142.00

Secador de Manos.
Con botón accionador.



Dimensiones:
vista frontal

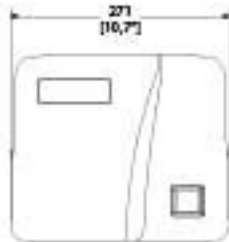

Dimensiones:
vista lateral

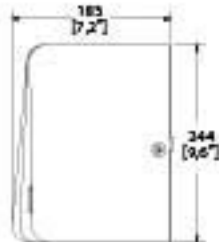

De corriente.

Tiempo de secado de 30 a 35 segundos.

Blanco

MB-1012

Blanco

\$ 14,631.00

Secador de Manos
TURBO.
Con sensor.



Dimensiones:
vista frontal

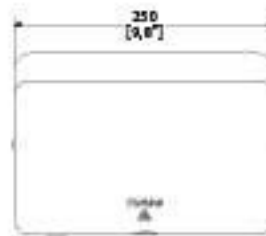

Dimensiones:
vista lateral

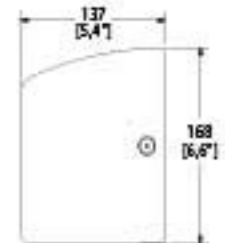

De corriente.

Tiempo de secado de 10 a 15 segundos.

Blanco

MB-1012-AI

Acero inoxidable

\$ 18,106.00

Secador de Manos
TURBO.
Con sensor.



Dimensiones:
vista frontal

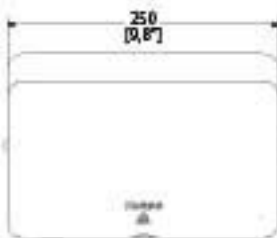

Dimensiones:
vista lateral

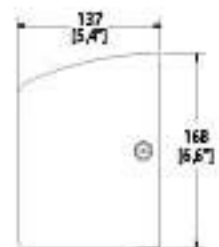

De corriente.

Tiempo de secado de 10 a 15 segundos.

AI

MB-1012-AIB

Acero inoxidable pulido

\$ 18,106.00

Secador de Manos
TURBO.
Con sensor.



Dimensiones:
vista frontal



Dimensiones:
vista lateral

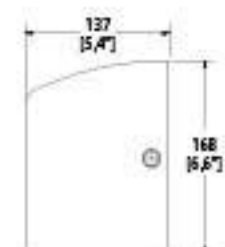

De corriente.

Tiempo de secado menor a 15 segundos.

AI

NOM NOM-003-SCFI-2014

MB-1100

Aluminio

\$ 6,636.00

Dosificador electrónico con sensor para jabón líquido.



Dimensiones vista frontal



Dimensiones vista lateral



Requiere baterías alcalinas AA.



AL

MB-1101

Aluminio

\$ 7,773.00

Dosificador electrónico con sensor para jabón de espuma.



Dimensiones vista frontal

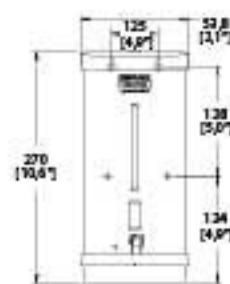

Dimensiones vista lateral

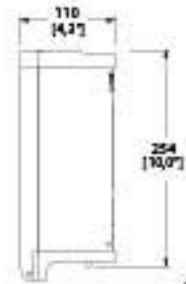

Requiere baterías alcalinas AA.



AL

MB-1102-AIB

Acero pulido de alto brillo

\$ 6,636.00

Dosificador electrónico con sensor para jabón líquido.



Dimensiones vista frontal



Dimensiones vista lateral

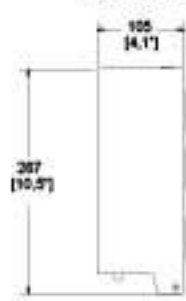

Requiere baterías alcalinas AA.



AP

MB-1103-AIB

Acero pulido de alto brillo

\$ 7,773.00

Dosificador electrónico con sensor para jabón de espuma.



Dimensiones vista frontal



Dimensiones vista lateral

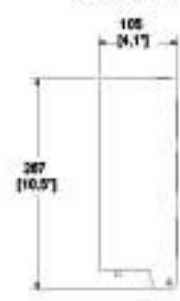

Requiere baterías alcalinas AA.



AP

NOM NOM-001-SCFI-2018

PEDESTAL PARA DOSIFICADORES DE JABÓN O GEL

PD-01-AI

Satin, acero inoxidable

\$ 3.918.00



Dimensiones:
vista frontal

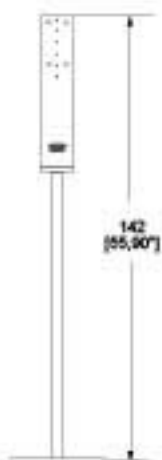

Dimensiones:
vista lateral

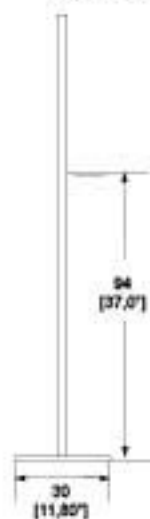

Compatibilidad con dosificadores:
MB-1100, MB-1101, MB-1102-AIB y MB-1103-AIB.



S/AI



ACABADOS



CR
Cromo

FLUXÓMETROS



Fluxómetros para W.C. y mingitorio de manija.



Fluxómetros para W.C. y mingitorio de pedal.



Fluxómetros para W.C. de cuerpo oculto de pedal.



Fluxómetros electrónicos para W.C. y mingitorio.

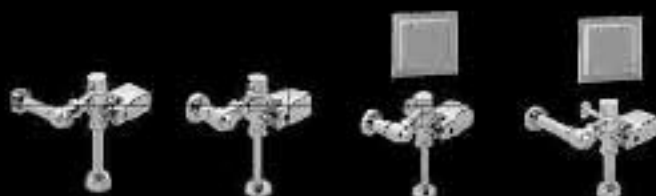

Tecnologías innovadoras y certificaciones:





Contamos con Fluxómetros de 6, 4.8, 3, 1 y 0.5 litros de agua por descarga.

Y ahora con 3.5 litros para tazas para fluxómetros NAO, NAO17 y NAO a pared.



NOM

Todos nuestros fluxómetros cumplen con la Norma Oficial Mexicana NOM-002-CONAGUA-2021 "Aparatos y accesorios de uso sanitario".

Visite nuestra página web para consultar y descargar fichas técnicas e instructivos de instalación.
helvex.com    



FLUXÓMETROS



FLUXÓMETROS ELECTRÓNICOS PARA WC Y MINGITORIOS

• Con sensor electrónico de corriente o de batería.



• Descarga de 3,5, 4,8 y 6 L en Taza flux. Descarga de 0,5, 1 y 3 L para mingitorio.



Botón con recubrimiento antibacterial.

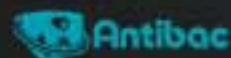

FLUXÓMETRO DE CUERPO OCULTO DE PEDAL PARA WC

• Spud de 38 mm.
• 4,8 LPD.

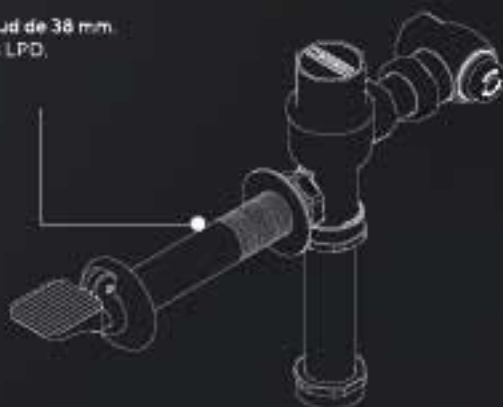

FLUXÓMETROS PARA WC Y MINGITORIO DE PALANCA

• Palanca con recubrimiento antibacterial.

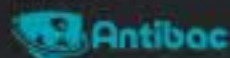

• Descarga de 3,5, 4,8 y 6 L en Taza flux. Descarga de 0,5, 1 y 3 L para mingitorio.

HELVEX

Garantía de Calidad



Productos con uso eficiente de agua.



Garantía Helvex en acabado cromo de 10 años y resto de acabados 2 años.



110-WC-4.8

Cromo

\$7,604.00



Fluxómetro de manija para taza flux, **spud de 38 mm** **4.8 L** por descarga.

Presión mínima requerida 1.00 kg/cm²

110-38

Cromo

\$7,604.00

Fluxómetro de manija para taza flux, **spud de 38 mm** **6 L** por descarga.

Presión mínima requerida 1.00 kg/cm².



110-38-3.5

Cromo

\$7,604.00



Fluxómetro de manija para taza flux Nao, Nao17 y Nao a pared, **spud de 38 mm** **3.5 L** por descarga.

Presión mínima requerida 2.00 kg/cm².

Manija con recubrimiento.



Dimensiones: vista frontal

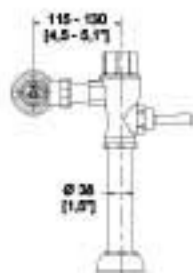

Dimensiones: vista lateral

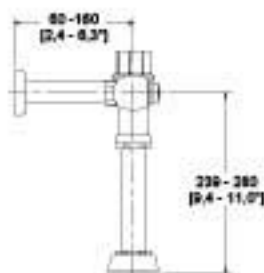

NOM NOM-002-CONAGUA-2021

117-38

Cromo

\$8,008.00

Fluxómetro de manija para taza flux, **spud de 38 mm** **6 L** por descarga, niple recto de 60 cm.

Presión mínima requerida 1.00 kg/cm².



Dimensiones: vista frontal

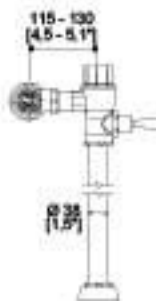

Dimensiones: vista lateral

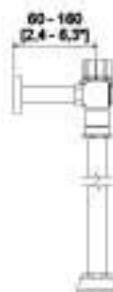

Manija con recubrimiento.



FLUXÓMETROS MECÁNICOS DE PEDAL EXPUESTO PARA INODORO

310-WC-4.8

Cromo

\$ 9,146.00



Flujómetro de pedal expuesto para taza flux, **spud de 38 mm** **4.8 L** por descarga.

Presión mínima requerida 1.00 kg/cm².

310-38

Cromo

\$ 9,146.00

Flujómetro de pedal expuesto para taza flux, **spud de 38 mm** **6 L** por descarga.

Presión mínima requerida 1.00 kg/cm².



310-38-3.5

Cromo

\$ 9,146.00



Flujómetro de pedal expuesto para taza flux Nao, Nao17 y Nao a pared, **spud de 38 mm** **3.5 L** por descarga.

Presión mínima requerida 2.00 kg/cm².

Acabado.



Dimensiones:
vista frontal

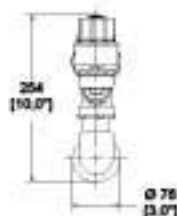

Dimensiones:
vista lateral

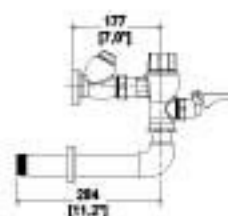

NOM NOM-002-CONAGUA-2021

FLUXÓMETROS MECÁNICOS DE PEDAL EXPUESTO PARA MINGITORIO

310-19-0.5

Cromo

\$ 9,146.00



Fluxómetro de pedal expuesto para mingitorio, **spud de 19 mm** 0.5 L por descarga.

Presión mínima requerida 1.00 kg/cm².

310-19-1

Cromo

\$ 9,146.00

Fluxómetro de pedal expuesto para mingitorio, **spud de 19 mm** 1 L por descarga.

Presión mínima requerida 1.00 kg/cm².



310-19

Cromo

\$ 9,146.00

Fluxómetro de pedal expuesto para mingitorio, **spud de 19 mm** 3 L por descarga.

Presión mínima requerida 1.00 kg/cm².

Acabado.



CR

Dimensiones:
vista frontal

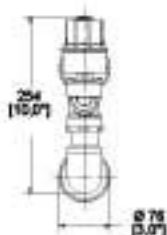

Dimensiones:
vista lateral

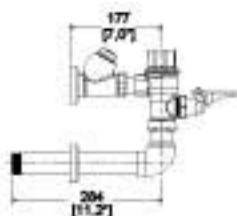

NOM NOM-002-CONAGUA-2021



ANDROS

C-20
Cromo

\$ 1.561.00

Juego de manerales grandes.



Dimensiones:
vista frontal

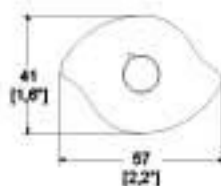

Dimensiones:
vista lateral



Acabado.



CR

TRÍPOLI

C-35
Cromo

\$ 1.551.00

Juego de manerales grandes.



Dimensiones:
vista frontal

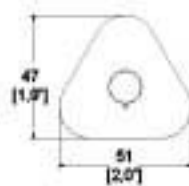

Dimensiones:
vista lateral

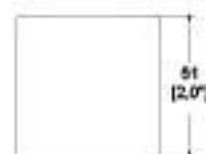

Acabado.



CR

ANTIQUA

C-37
Cromo

\$ 2.467.00

Juego de manerales grandes.



Dimensiones:
vista frontal

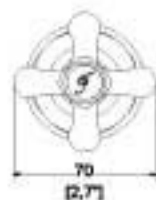

Dimensiones:
vista lateral

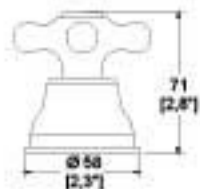

Incluye chapetones.



CR

ANTARES

C-44
Cromo

\$ 1.447.00

Juego de manerales grandes.



Dimensiones:
vista frontal



Dimensiones:
vista lateral

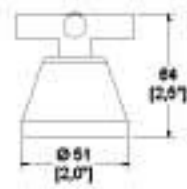

Incluye chapetones.



CR

FLUXÓMETROS MECÁNICOS DE MANIJA PARA MINGITORIO

185-19-0.5

Cromo

\$7,604.00



Fluxómetro de manija
para mingitorio,
spud de 19 mm
0.5 L por descarga.

Presión mínima requerida 1.00 kg/cm²

185-19-1

Cromo

\$7,604.00

Fluxómetro de manija
para mingitorio,
spud de 19 mm
1 L por descarga.

Presión mínima requerida 1.00 kg/cm²



185-19

Cromo

\$7,604.00

Fluxómetro de manija
para mingitorio,
spud de 19 mm
3 L por descarga.

Presión mínima requerida 1.00 kg/cm²

Manija con recubrimiento.



CR

Dimensiones:
vista frontal

Dimensiones:
vista lateral

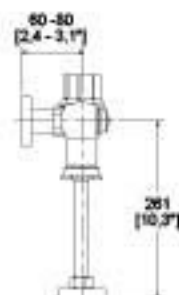
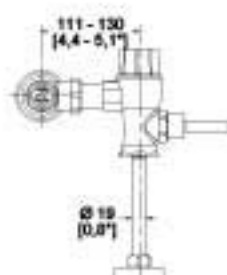

NOM NOM-002-CONAGUA-2021

FLUXÓMETRO MECÁNICO DE PEDAL PARA INODORO DE CUERPO OCULTO

312-WC-4.8

Cromo

\$ 9,127.00



Fluxómetro de pedal expuesto para taza flux cuerpo oculto, spud de 38 mm, 4.8 L por descarga.

Dimensiones:
vista frontal



Dimensiones:
vista lateral

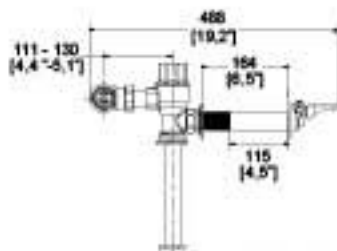

Presión mínima requerida 1.00 kg/cm².



CR



NOM NOM-002-CONAGUA-2021

FLUXÓMETROS ELECTRÓNICOS DE CORRIENTE PARA INODOROS

FC-110-WC-4.8

Cromo

\$ 20,435.00

Flujómetro de sensor electrónico de corriente para taza flux, **spud de 38 mm**, **4.8 L** por descarga.

Presión mínima requerida 1.00 kg/cm².



FC-110-38-3.5

Cromo

\$ 20,435.00

Flujómetro de sensor electrónico para taza flux Nao, Nao17 y Nao a pared, **spud de 38 mm**, **3.5 L** por descarga.

Presión mínima requerida 2.00 kg/cm².



Botón con recubrimiento.



De corriente.



Dimensiones:
vista frontal

Dimensiones:
vista lateral

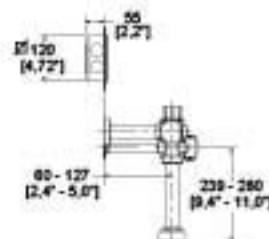
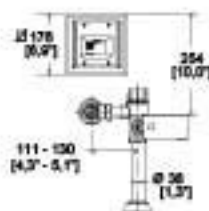

NOM NOM-002-CONAGUA-2021

FLUXÓMETROS ELECTRÓNICOS DE CORRIENTE PARA MINGITORIOS

FC-185-19-0.5

Cromo

\$ 20,435.00



Fluxómetro de sensor electrónico de corriente para mingitorio, spud de 19 mm. 0.5 L por descarga.



FC-185-19-1

Cromo

\$ 20,435.00

Fluxómetro de sensor electrónico para mingitorio, spud de 19 mm. 1 L por descarga.



FC-185-19

Cromo

\$ 20,435.00

Fluxómetro de sensor electrónico para mingitorio, spud de 19 mm. 3 L por descarga.



Botón con recubrimiento.



CR

Presión mínima requerida 1.00 kg/cm².

De corriente.



Dimensiones:
vista frontal

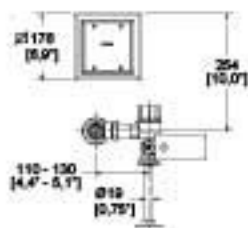

Dimensiones:
vista lateral

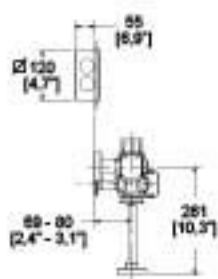

NOM NOM-002-CONAGUA-2021



FLUXÓMETROS ELECTRÓNICOS DE BATERÍA PARA INODOROS

FB-110-WC-4.8

Cromo

\$ 20,435.00



Fluxómetro de sensor electrónico de baterías para taza flux, **spud de 38 mm.**
4.8 L por descarga.

Presión mínima requerida 1.00 kg/cm²



FB-110-38

Cromo

\$ 20,435.00

Fluxómetro de sensor electrónico de baterías para taza flux, **spud de 38 mm.**
6 L por descarga.

Presión mínima requerida 1.00 kg/cm².



FB-110-38-3.5

Cromo

\$ 20,435.00



Fluxómetro de sensor electrónico de baterías para taza flux Nao, Nao17 y Nao a pared, **spud de 38 mm.**
3.5 L por descarga.

Presión mínima requerida 2.00 kg/cm²

Botón con recubrimiento.



CR

Requiere baterías alcalinas AA.



Dimensiones:
vista frontal

Dimensiones:
vista lateral

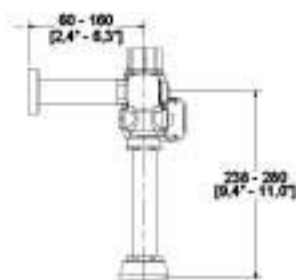
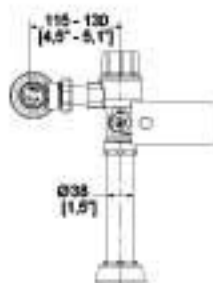

NOM NOM-002-CONAGUA-2021

FLUXÓMETROS ELECTRÓNICOS DE BATERÍA PARA MINGITORIOS

FB-185-19-0.5

Cromo

\$ 20,435.00



Fluxómetro de sensor electrónico de baterías para mingitorio **spud de 19 mm.**
0.5 L por descarga.

Presión mínima requerida 1.00 kg/cm².



FB-185-19-1

Cromo

\$ 20,435.00

Fluxómetro de sensor electrónico de baterías para mingitorio **spud de 19 mm.**
1 L por descarga.

Presión mínima requerida 1.00 kg/cm².



FB-185-19

Cromo

\$ 20,435.00

Fluxómetro de sensor electrónico de baterías para mingitorio **spud de 19 mm.**
3 L por descarga.

Presión mínima requerida 1.00 kg/cm².

Botón con recubrimiento.



CR

Requiere baterías alcalinas AA.



Dimensiones:
vista frontal

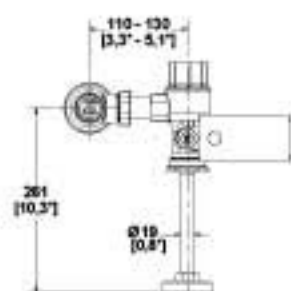

Dimensiones:
vista lateral

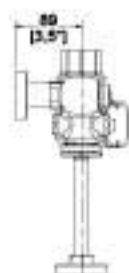

NOM NOM-002-CONAGUA-2021



ACABADOS



Blanco



Marfil

MUEBLES SANITARIOS Y LAVABOS

Más allá de su excelente funcionalidad, garantizada por la histórica calidad que nos acompaña, nuestros muebles sanitarios son reflejo de elegancia, estilo y confort expresado a través de texturas suaves, líneas curvas y delgadas, cuerpos sólidos y fuertes y un acabado tan brillante que te deslumbrará.

La labor de madurar una línea de producción y generar diseños más eficientes y atractivos, han sido retos que hoy rinden frutos, te invitamos a conocer nuestros nuevos modelos de muebles sanitarios, diseñados para brindarte el mayor confort y una mejor experiencia.



WC.



One Piece.



Tazas flux.



Asientos.



Mingitorios.



Lavabos.



MUEBLES SANITARIOS Y LAVABOS



Cerámica al alto brillo



Diversidad de diseños, adaptables a las necesidades. Sobreponer, bajocubierta y sobrecubierta.

GRUESO
ESPESOR



Descargas de 3.8 y 4.8 L.

Sistemas de descarga:
LIMPIEZA TOTAL
¡NO SE TAPAN!



VÓRTICE



TURVEX

Modelos disponibles
de altura tradicional
y altura confortable.



Trampa esmaltada
cero residuos, cero
proliferación de bacterias.



Mingitorios sin consumo
de agua, con sistema
TDS2
QUE EVITA LOS
MALOS OLORES

HELVEX

Garantía de Calidad

65
años de
garantía en
cerámica

OP RIVOLI PLUS 4.8 LPD

- Inodoro ONE PIECE RIVOLI PLUS elongado.
- Una sola pieza.
- Taza de altura confortable con trampa oculta.
- Descarga de 4.8 LPD.
- Botón accionador.
- Sistema Turvex.
- Cuenta con 3 jets para una limpieza total.
- Incluye asiento de cierre lento con antibacterial.



OP RIVOLI PLUS



Color Blanco

\$ 11,919.00

Dimensiones:
vista frontal



Dimensiones:
vista lateral



Efecto Turvex



Taza alargada



Trampa oculta



Descarga múltiple



Antibacterial



Cierre lento



Mayor altura



ECOLVER

NOM NOM-005-CONAGUA-1996

Los precios incluyen IVA.

217

HELVEX
Garantía de Calidad



MANERALES

ALBATROS

C-45
Cromo

\$ 1.447.00

Juego de manerales grandes.



Dimensiones:
vista frontal



Dimensiones:
vista lateral



Incluye chapetones.



CR

ANTEA

C-46
Cromo

\$ 1.077.00

Juego de manerales grandes.



Dimensiones:
vista frontal



Dimensiones:
vista lateral

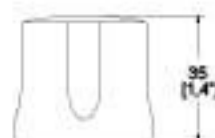

Acabado.



CR

ÁTICA

C-59
Cromo

\$ 1.447.00

Juego de manerales grandes.



Dimensiones:
vista frontal



Dimensiones:
vista lateral

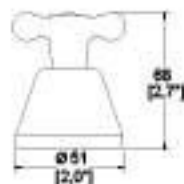

Incluye chapetones.



CR

NUVA

C-62
Cromo

\$ 2.862.00

Juego de manerales grandes.



Dimensiones:
vista frontal

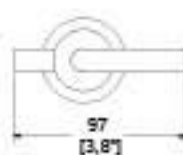

Dimensiones:
vista lateral

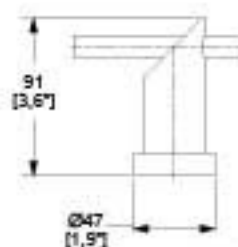

Incluye chapetones.



CR



OP CAPRI PLUS 4.8 LPD

- Inodoro **ONE PIECE CAPRI PLUS** cuadrado.
- Una sola pieza.
- Taza de altura confortable con trampa **oculta**.
- **Descarga de 4.8 LPD.**
- **Sistema Turvex.**
Cuenta con **3 jets** para una limpieza total.
- Botón accionador.
- Incluye asiento de cierre lento con antibacterial.



OP CAPRI PLUS



\$ 11,919.00

Dimensiones:
vista frontal

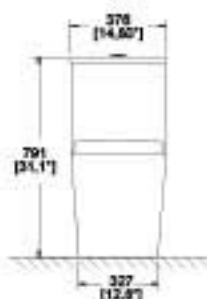

Dimensiones:
vista lateral



Efecto Turvex



Trampa oculta



Antibacterial



Cierre lento



Mayor altura



Ecolux



Agua limpia

NOM NOM-005-CONAGUA-1996



Garantía de Calidad

65
años de
garantía en
cerámica



WC MURANO 4.8 LPD

- Inodoro, taza y tanque **MURANO** elongado.
- Taza elongada de altura confortable con trampa **oculta**.
- **Descarga de 4.8 LPD.**
- Botón accionador.
- **Sistema Turvex.**
Cuenta con **3 jets** para una limpieza total.
- Incluye asiento de cierre lento con antibacterial.



WC MURANO



\$ 10,662.00

Dimensiones:
vista frontal



Dimensiones:
vista lateral

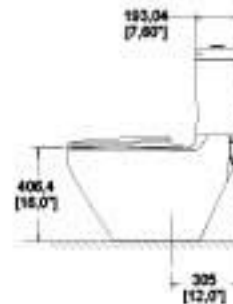

TANQUE MURANO

\$ 4,264.00



TAZA MURANO

\$ 6,398.00



Efecto Turvex



Trampa oculta



Taza alargada



Antibacterial



Cierre lento



Mayor altura



NOM NOM-005-CONAGUA-1996

WC MIURA16 TCC

TECNOLOGÍA CERO CONTACTO



EVITA EL CONTACTO, PREVIENE INFECCIONES

- Mayor higiene.
- Rango de detección ajustable.
- Instalación versátil, elija la posición de instalación a su gusto.

SIRVE COMO APOYO PARA ADULTOS MAYORES, NIÑOS O PERSONAS CON CAPACIDADES DIFERENTES QUE NECESITAN AYUDA.



SENSOR DE BATERÍAS.
INDEPENDIENTE, SE PUEDE INSTALAR DENTRO DE UN RANGO DE 5 M.

INCLUYE BOTÓN PARA DESCARGAS MANUALES.



INCLUYE ASIENTO AT-5 DE CIERRE LENTO CON ANTIBACTERIAL.



DESALOJA 1 KG.

ALTURA MAYOR 16.6".





WC MIURA16 TCC

- Inodoro, taza y tanque **MIURA16 TCC** elongado.
- Taza elongada de altura confortable con trampa **oculta**.
- **Descarga de 4.8 LPD.**
- **Desaloja 1 Kg.**
- Botón de sensor de baterías independiente.
- Incluye botón lateral para descargas manuales.
- **Sistema Turvex.**
Cuenta con **4 jets** para una limpieza total.
- Incluye asiento **AT-5 de cierre lento con antibacterial.** 
- También compatible con **ATEy ATM.**

WC MIURA16 TCC



\$ 13,357.00

Dimensiones:
vista frontal



Dimensiones:
vista lateral

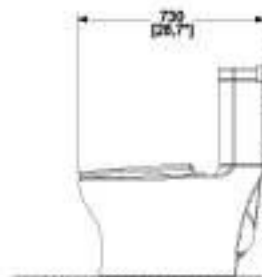

TANQUE MIURA16 TCC

Incluye botón de sensor independiente y botón manual lateral.

\$ 7,802.00



TAZA MIURA16

\$ 5,555.00



Electo Turvex



Trampa oculta



Taza alargada



Antibacterial



Cierre lento



Mayor altura



Water saving



SCOLVER

NOM NOM-009-CONAGUA-2001

65
años de
garantía en
cerámica



WC MIURA16 4.8 LPD

- Inodoro, taza y tanque **MIURA16** elongado.
- Taza elongada de altura confortable con trampa **oculta**.
- Descarga de **4.8 LPD**.
- Desaloja **1 kg**.
- Sistema **Turvex**. Cuenta con **4 jets** para una limpieza total.
- Botón accionador.
- Incluye asiento **AT-5** de cierre lento con antibacterial. 
- También compatible con **ATE Y ATM**.

WC MIURA16



Color Blanco

\$ 9,258.00

Dimensiones:
vista frontal



Dimensiones:
vista lateral

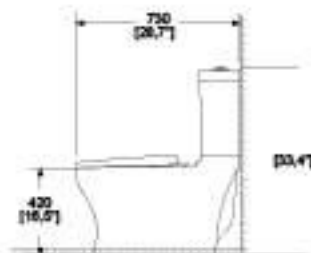

TANQUE MIURA16

\$ 3,703.00



Color Blanco

TAZA MIURA16

\$ 5,555.00



Color Blanco

NOM NOM-009-CONAGUA-2001



Efecto Turvex



Trampa oculta



Taza alargada



Antibacterial



Cierre lento



Mayor altura

HELVEX
Garantía de Calidad



65
años de
garantía en
cerámica

WC BOLMEN16 4.8 LPD

- Inodoro, taza y tanque **BOLMEN16** elongado.
- Taza elongada de altura confortable con trampa **expuesta**.
- **Descarga de 4.8 LPD.**
- **Sistema Turvex.**
Para una limpieza total.
- Botón accionador.
- **No incluye asiento**, se recomiendan asientos **AT-1, AT-2, ATE y ATM.**



WC BOLMEN16



\$ 5,555.00

WC BOLMEN16 M



\$ 5,555.00

Dimensiones:
vista frontal

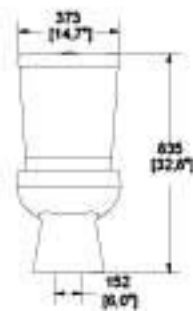

Dimensiones:
vista lateral

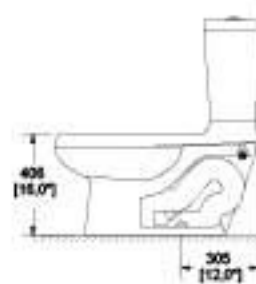

TANQUE BOLMEN16

\$ 2,221.00



TANQUE BOLMEN16 M

\$ 2,221.00



TAZA BOLMEN16

\$ 3,334.00



TAZA BOLMEN16 M

\$ 3,334.00



Efecto Turvex



Taza alargada



Trampa expuesta



Mayor altura



Save Water



SCOLVEX

NOM NOM-009-CONAGUA-2001

65

años de
garantía en
cerámica



WC RÓDANO16 4.8 LPD

- Inodoro, taza y tanque **RÓDANO16** elongado.
- Taza elongada de altura confortable con trampa **expuesta**.
- Descarga de **4.8 LPD**.
- **Sistema Turvex.**
Para una limpieza total.
- Botón accionador.
- **No incluye asiento**, se recomiendan asientos **AT-1, AT-2, ATE y ATM.**

WC RÓDANO16



Color Blanco

\$ 5,555.00

WC RÓDANO16 M



Color Marfil

\$ 5,555.00

Dimensiones:
vista frontal



Dimensiones:
vista lateral

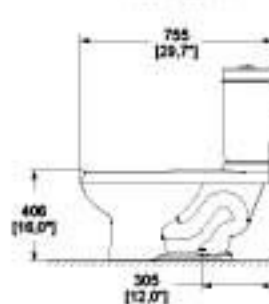

TANQUE RÓDANO16

\$ 2,221.00



Color Blanco

TANQUE RÓDANO16 M

\$ 2,221.00



Color Marfil

TAZA RÓDANO16

\$ 3,334.00



Color Blanco

TAZA RÓDANO16 M

\$ 3,334.00



Color Marfil

NOM NOM-009-COAGUA-2001



Efecto Turvex



Taza alargada



Trampa expuesta



Mayor altura

Los precios incluyen IVA

WC OLIMPIA 3.8 LPD

- Inodoro, taza y tanque **OLIMPIA** redondo.
- Taza redonda de altura tradicional con trampa **expuesta**.
- **Descarga de 3.8 LPD.**
- **Sistema Vórtice.** Limpieza total, no se tapa.
- Botón accionador.
- **No incluye asiento**, se recomiendan asientos **ATR-1 y ATR-1-M.**

65
años de
garantía en
cerámica



WC OLIMPIA

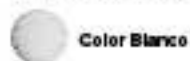

Color Blanco

\$ 4,055.00

WC OLIMPIA M



Color Marfil

\$ 4,055.00

Dimensiones:
vista frontal

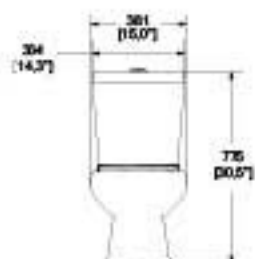

Dimensiones:
vista lateral



TANQUE OLIMPIA

\$ 1,620.00



Color Blanco

TANQUE OLIMPIA M

\$ 1,620.00



Color Marfil

TAZA OLIMPIA

\$ 2,435.00



Color Blanco

TAZA OLIMPIA M

\$ 2,435.00



Color Marfil



Sistema Vórtice



Taza redonda



Trampa expuesta



Altura tradicional



Water Saver



ECOLVEX

NOM NOM-009-CONAGUA-2001

65

años de
garantía en
cerámico



WC DRAKAR 4.8 LPD

- Inodoro, taza y tanque **DRAKAR** elongado.
- Taza elongada de altura tradicional con trampa **expuesta**.
- Descarga de **4.8 LPD**.
- **Sistema Vórtice**. Limpieza total, no se tapa.
- Botón accionador.
- **No incluye asiento**, se recomiendan asientos **AT-1, AT-2, ATE y ATM**.

WC DRAKAR



Color Blanco

\$ 4,545.00

WC DRAKAR M



Color Marfil

\$ 4,545.00

Dimensiones:
vista frontal



Dimensiones:
vista lateral

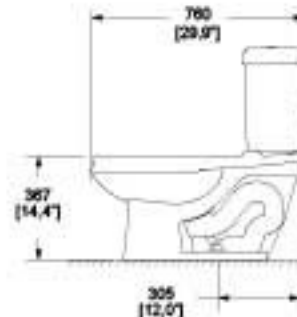

TANQUE DRAKAR

\$ 1,820.00



Color Blanco

TANQUE DRAKAR M

\$ 1,820.00



Color Marfil

TAZA DRAKAR

\$ 2,725.00



Color Blanco

TAZA DRAKAR M

\$ 2,725.00



Color Marfil

NOM NOM-009-CONAGUA-2001



Sistema Vórtice



Taza alargada



Trampa expuesta



Altura tradicional

Los precios incluyen IVA

NUVA

C-65
Cromo

\$ 2.862.00

Juego de manerales grandes.



Dimensiones:
vista frontal



Dimensiones:
vista lateral

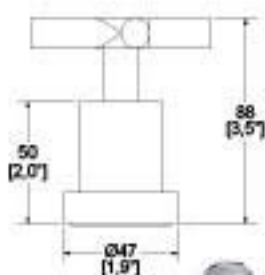

Incluye chapetones.

CR

PRIMMA

C-67
Cromo

\$ 1.504.00

Juego de manerales grandes.



Dimensiones:
vista frontal

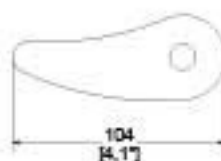

Dimensiones:
vista lateral

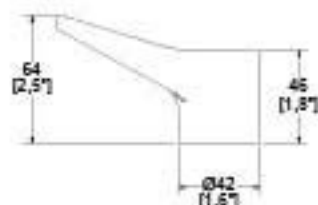

Acabado.

CR

KÚBICA

C-69
Cromo

\$ 2.982.00

Juego de manerales grandes.



Dimensiones:
vista frontal

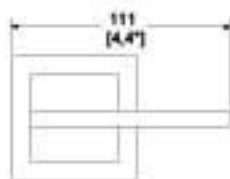

Dimensiones:
vista lateral

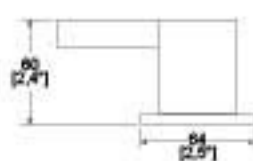

Incluye chapetones.

CR

PREMIER

C-70
Cromo

\$ 2.482.00

Juego de manerales grandes.



Dimensiones:
vista frontal

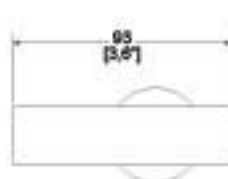

Dimensiones:
vista lateral

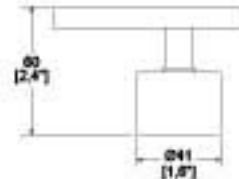

Acabado.

CR

65
años de
garantía en
cerámica

WC DRAKAR16 4.8 LPD

- Inodoro, taza y tanque **DRAKAR16** elongado.
- Taza elongada de altura confortable con trampa **expuesta**.
- **Descarga de 4.8 LPD.**
- **Sistema Turvex.**
Para una limpieza total.
- Botón accionador.
- **No incluye asiento, se recomiendan asientos AT-1, AT-2, ATE y ATM.**



WC DRAKAR16



Color Blanco

\$ 4,545.00

Dimensiones:
vista frontal



Dimensiones:
vista lateral



TANQUE DRAKAR16

\$ 1,820.00



Color Blanco

TAZA DRAKAR16

\$ 2,725.00



Color Blanco



Efecto Turvex



Taza alargada



Trampa expuesta



Mayor altura



Save water



SCSOLVES

NOM NOM-009-CONAGUA-2001



WC OPTION 4.8 LPD

- Ideal para espacios reducidos.
- Inodoro, taza y tanque **OPTION** elongado compacto.
- Taza elongada compacta, de altura confortable con trampa **expuesta**.
- Descarga de **4.8 LPD**.
- Sistema **Turvex**. Cuenta con **4 jets** para una limpieza total.
- Botón accionador.
- **No incluye asiento**, se recomiendan asientos **AT-1, AT-2 y AT-5**.

WC OPTION



\$ 3,879.00

Dimensiones:
vista frontal



Dimensiones:
vista lateral

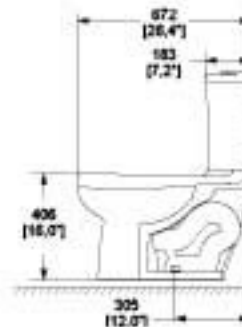

TANQUE OPTION

\$ 1,550.00



Color Blanco

TAZA OPTION

\$ 2,329.00



Color Blanco

NOM NOM-009-CONAGUA-2001



Efecto Turvex



Taza alargada



Trampa expuesta



Mayor altura

Los precios Incluyen IVA

WC AUSTRAL CON BOTÓN 3.8 LPD

- Ideal para espacios reducidos.
- Inodoro, taza y tanque **AUSTRAL** elongado compacto.
- Taza elongada compacta, de altura comfortable con trampa **expuesta**.
- Descarga de **3.8 LPD**.
- Sistema **Turvex**.
Para una limpieza total.
- Botón accionador.
- **No incluye asiento**, se recomiendan asientos **AT-1, AT-2y AT-5**.



WC AUSTRAL



Color Blanco

\$ 3,969.00

Dimensiones:
vista frontal



Dimensiones:
vista lateral



TANQUE AUSTRAL

\$ 1,825.00



Color Blanco

TAZA AUSTRAL

\$ 2,144.00



Color Blanco



Efecto Turvex



Taza alargada



Trampa expuesta



Mayor altura



Eco



Ecolux

NOM NOM-009-CONAGUA-2001

65
años de
garantía en
cerámica



WC AUSTRAL CON PALANCA 3.8 LPD

- Ideal para espacios reducidos.
- Inodoro, taza y tanque **AUSTRAL** elongado compacto.
- Taza elongada compacta, de altura confortable con trampa **expuesta**.
- Descarga de **3.8 LPD**.
- Sistema **Turvex**. Para una limpieza total.
- Palanca accionadora.
- **No incluye asiento**, se recomiendan asientos **AT-1, AT-2 y AT-5**.

WC AUSTRAL P



Color Blanco

\$ 3,969.00

Dimensiones:
vista frontal



Dimensiones:
vista lateral



TANQUE AUSTRAL P

\$ 1,825.00



Color Blanco

TAZA AUSTRAL

\$ 2,144.00



Color Blanco

NOM NOM-009-CONAGUA-2001



Efecto Turvex



Taza alargada



Trampa expuesta



Mayor altura

Los precios incluyen IVA

231

HELVEX
Cerámica de Calidad

AT-1

Blanco

\$ 1.160.00

AT-1-M

Marfil

\$ 1.160.00

Asiento para WC **elongado**, frente abierto, cierre lento con antibacterial.



Dimensiones
vista cenital

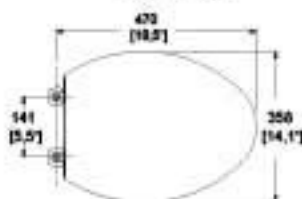

Dimensiones
vista lateral



Colores.



AT-2

Blanco

\$ 736.00

Asiento para WC **elongado**, frente abierto, cierre estándar con antibacterial.



Dimensiones
vista cenital

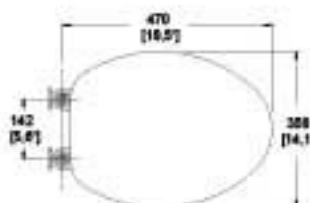

Dimensiones
vista lateral



Color.



ASIENTOS CON SISTEMA DE SUJECIÓN REFORZADO

ATR-1

Blanco

\$723.00

ATR-1-M

Marfil

\$723.00

Asiento para WC **redondo**, frente abierto, cierre estándar con antibacterial.



Dimensiones:
vista cenital

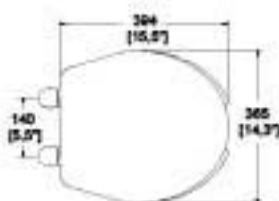

Dimensiones:
vista lateral



Colores.

Blanco Marfil

AT-4

Blanco

\$1433.00

Asiento para WC **elongado**, con tapa envolvente, frente abierto, cierre lento con antibacterial.



Dimensiones:
vista cenital

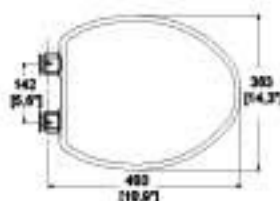

Dimensiones:
vista lateral



Color.

Blanco



AT-5

Blanco

\$1160.00

Asiento para WC **elongado**, con tapa envolvente, frente abierto, cierre lento con antibacterial.



Dimensiones:
vista cenital

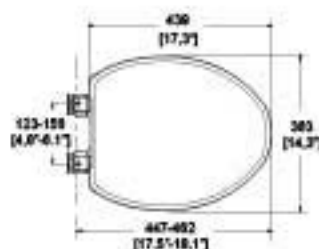

Dimensiones:
vista lateral



Color.

Blanco

ATE ASIENTO ELECTRÓNICO

ATE



Color Blanco

\$ 24.936.00

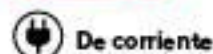

De corriente



- **Compatible con WC's elongados:**

OP Rivoli Plus.
WC Miura16.
WC Miura16 TCC.
WC Ródano16.
WC Bolmen16.
WC Drakar.
WC Drakar16.

- **No compatible con WC's redondos o elongados compactos.**

- **Con funciones de limpieza, secado y calefacción**
Incluye control remoto.

Dimensiones
vista cenital

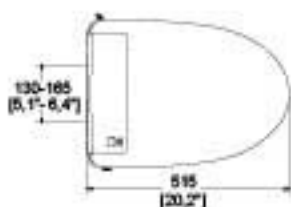

Dimensiones:
vista frontal



Taza alargada



No baterías



Antibacterial



Cierre lento



Antibac®



CARACTERÍSTICAS

- Para **WC's** elongados.
- Labio cerrado.
- Asiento **antibacterial**.
- Utiliza **corriente**.
- **Luz** nocturna.
- Memoria para **2 perfiles de usuario**.
- **Secado** con aire tibio a **6 niveles**.
- Distancia de **chorro** de agua de **5 niveles**.

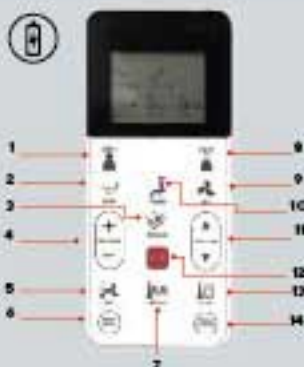

- 1 Usuario 1.
- 2 Limpieza trasera.
- 3 Masaje.
- 4 Presión del agua.
- 5 Temperatura de secado.
- 6 Ahorro de energía.
- 7 Temperatura del agua.
- 8 Usuario 2.
- 9 Secado.
- 10 Limpieza delantera.
- 11 Posición de la boquilla de rociado.
- 12 Parar.
- 13 Temperatura del asiento.
- 14 Limpieza de la boquilla de rociado.



ASIENTO ATM TIPO BIDET MECÁNICO

ATM

 Color Blanco

\$ 4.110.00



Limpeza alternativa al papel higiénico, ya que incluye un dispositivo tipo bidet, que arroja agua para limpieza frontal y rectal, generando ahorros sustanciales.

Es el sustituto ideal de papel higiénico, ya que ofrece mayor limpieza y suavidad.

Ideal para personas con problemas de hemorroides, movilidad o con operaciones recientes.

- **Asiento mecánico**, con funciones tipo Bidet;
Compatible con :
WC's elongados:
OP Rivoli Plus.
WC Miura16.
WC Miura16 TCC.
WC Ródano16.
WC Bolmen16.
WC Drakar.
WC Drakar16.
- **No compatible con WC's redondos o elongados compactos.**
- **Incluye antibacterial.**
- **Presión de agua mínima requerida 0.40 kg/cm².**

Dimensiones
vista cenital

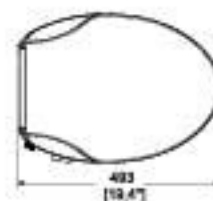

Dimensiones
vista frontal



De cierre lento
Evita que el asiento
se maltrate.

**Dispositivo que
arroja agua**
para limpieza frontal
(tipo bidet) y posterior.

Labio cerrado.

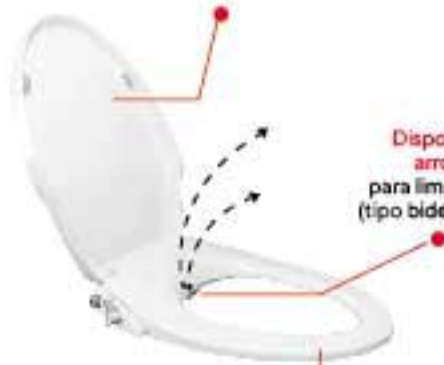

Taza alargada



No baterías



Antibacterial



Cierre lento



3 niveles de
intensidad



TZF NAO

Blanco

\$ 5,165.00

Taza Nao para fluxómetro, **elongada**, trampa expuesta 3.5 LPD / 4.8 LPD.



Dimensiones:
vista frontal

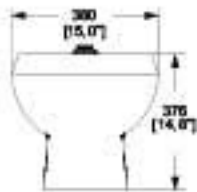

Dimensiones:
vista lateral



Cerámica al alto brillo, grado de calidad "A", grueso espesor en la cerámica para mayor resistencia, trampa esmaltada, base rectificada, descarga rápida, desalojo perfecto, no se tapa, sistema de sujeción reforzado, amplio espejo de agua que favorece la limpieza de la taza. **No incluye asiento.**

Blanco

TZF NAO17

Blanco

\$ 5,165.00

Taza Nao17 para fluxómetro, **elongada**, trampa expuesta. Altura confortable 3.5 LPD / 4.8 LPD.



Dimensiones:
vista frontal



Dimensiones:
vista lateral

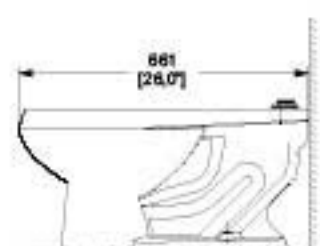

Cerámica al alto brillo, grado de calidad "A", grueso espesor en la cerámica para mayor resistencia, trampa esmaltada, base rectificada, descarga rápida, desalojo perfecto, no se tapa, sistema de sujeción reforzado, amplio espejo de agua que favorece la limpieza de la taza. **No incluye asiento.**

Blanco

Para las tazas NAO y NAO17 se recomienda el uso de los fluxómetros de 3.5, 4.8 y 6 Litros

DESALOJA 1 kg

Altura confortable
NAO17



NOM NOM-009-CONAGUA-2001



Sistema Vórtice



Desalojo perfecto



Taza alargada



Cerámicas



Modelos especiales que le ayudarán a obtener puntos para la certificación LEED



ECOLVEX



ASIENTOS PARA TAZAS CON FLUXÓMETRO

AF-1

Blanco

\$ 637.00

Asiento elongado para taza fluxómetro sin tapa.



Dimensiones:
vista frontal



Dimensiones:
vista lateral



Color:

Blanco

AF-2

Blanco

\$ 1.271.00

Asiento plus elongado para taza fluxómetro sin tapa con antibacterial

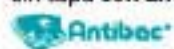

Dimensiones:
vista frontal



Dimensiones:
vista lateral



Asiento más robusto, con sistema de fijación reforzado. El asiento NO se mueve.

Blanco



MANERALES

PREMIER

C-70-EB
Ébano

\$ 2.853.00

Juego de manerales grandes.



Dimensiones:
vista frontal

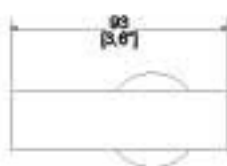

Dimensiones:
vista lateral

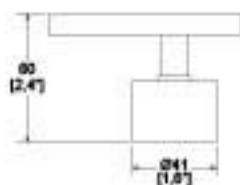

Incluye chapetones.



EB

KONOS

C-73
Cromo

\$ 2.482.00

Juego de manerales grandes.



Dimensiones:
vista frontal

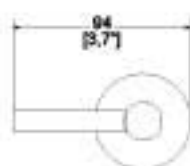

Dimensiones:
vista lateral

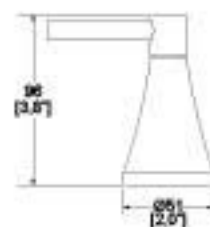

Acabado.



CR

TH-100

Cromo

\$ 773.00

Maneral central.



Dimensiones:
vista frontal



Dimensiones:
vista lateral

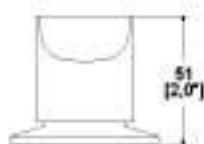

Incluye chapetón.



CR

TH-101

Cromo

\$ 1.114.00

Maneral central.



Dimensiones:
vista frontal



Dimensiones:
vista lateral

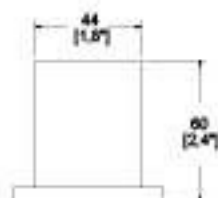

Incluye chapetón.



CR

TZF NAO P

Blanco

\$ 5,580.00

Taza para fluxómetro a pared.
Trampa semi oculta,
6 LPD.
Ecológico 3.5 LPD / 4.8 LPD.



Dimensiones:
vista cenital

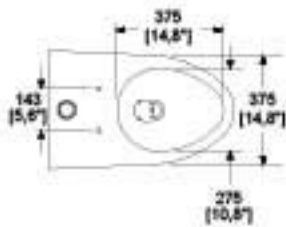

Dimensiones:
vista lateral

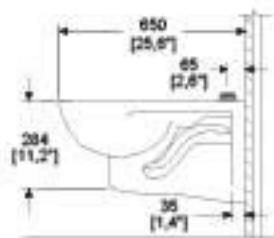

Diseño ergonómico.
Máxima eficiencia en descarga.
Cerámica porcelanizada de alto brillo; Calidad "A".
No incluye asiento; compatible con los modelos AF-1 y AF-2.

Blanco

S-TZF-P

Hierro fundido

\$ 4,511.00

Soporte para taza
TZF Nao a Pared
ajustable para dos alturas.

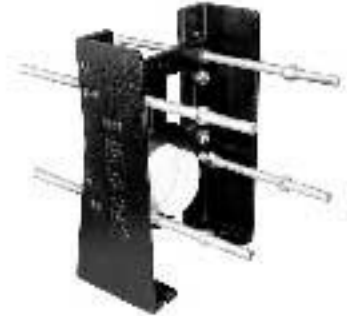

Dimensiones:
vista frontal

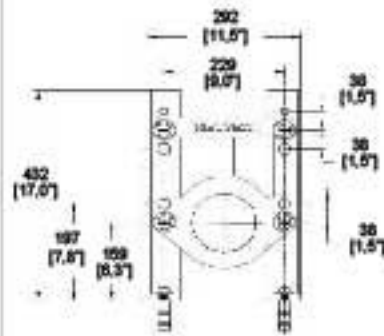

Dimensiones:
vista lateral

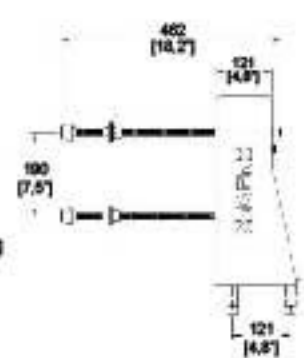

Carga máxima: 300 Kg.

Se recomienda instalar con
sistema de sujeción
S-TZF-P a pared (no incluido)

DESALOJA 1 kg

Altura confortable



NOM NOM-002-CONAGUA-2021



Sistema Vórtice



Desalajo perfecto



Taza alargada



Cerámicas múltiples



Modelos especiales que le
ayudarán a obtener puntos
para la certificación LEED



ECOLVEX

HELVEX
Garantía de Calidad

238

Los precios Incluyen IVA



MINGITORIOS TIPO CASCADA

MG FERRY

Blanco

\$ 8,691.00

Mingitorio Ferry
Flujo tipo cascada.
Se recomienda
su uso con fluxómetro
de 1 LPD ó 0.5 LPD.

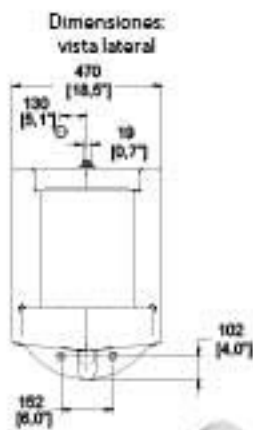
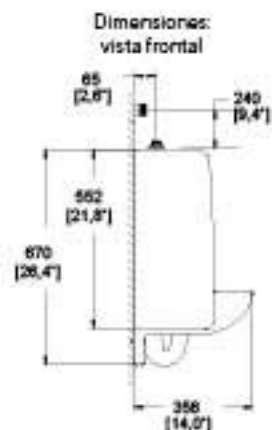

Cerámica al alto brillo, grado de calidad "A", grueso espesor en la cerámica para mayor resistencia, sistema de sujeción reforzado.

Blanco

MG MOJAVE

Blanco

\$ 6,653.00

Mingitorio Mojave
Flujo tipo cascada.
Se recomienda
su uso con fluxómetro
de 1 LPD.

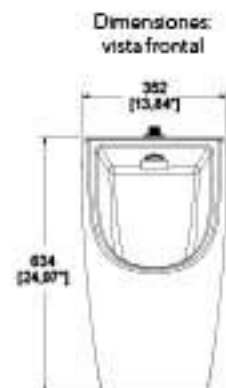

Cerámica al alto brillo, grado de calidad "A", grueso espesor en la cerámica para mayor resistencia, sistema de sujeción reforzado.

Blanco

NOM NOM-002-CONAGUA-2021



Modelos especiales que le ayudarán a obtener puntos para la certificación LEED



HELVEX
Garantía de Calidad

Los precios incluyen IVA

239





MINGITORIOS SECOS

MG MOJAVE TDS2

Blanco

\$ 8.965.00



Mingitorio Seco Mojave con sistema **TDS2** (Tecnología Drena y Sella con Doble esfera).

Dimensiones:
vista frontal



Dimensiones:
vista lateral



Color:

Blanco

MG NEGEV TDS2

Blanco

\$ 11.714.00



Mingitorio Seco Negev con sistema **TDS2** (Tecnología Drena y Sella con Doble esfera).

Dimensiones:
vista frontal



Dimensiones:
vista lateral

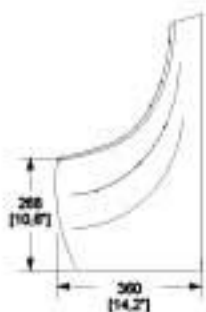

PIEDRO eco
CIHAC

Blanco



Modelos especiales que le ayudarán a obtener puntos para la certificación LEED.



**MG GOBI
TDS2**

Blanco

\$ 11.714,00



Mingitorio Seco Gobi con sistema **TDS2** (Tecnología Drena y Sella con Doble esfera).

Dimensiones:
vista frontal

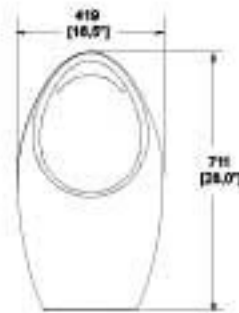

Dimensiones:
vista lateral



PERAL **eco**
CIHAC

Blanco



Modelos especiales que le ayudarán a obtener puntos para la certificación LEED



Cerámica al alto brillo, grado de calidad "A", grueso espesor en la cerámica para mayor resistencia, sistema de sujeción reforzado. Con sistema **TDS2** (Tecnología Drena y Sella con doble esfera). El sistema TDS2 no permite el paso de malos olores.

Con la Tecnología Drena y Sella de doble esfera,
cada mingitorio seco **PUEDA AHORRAR**
HASTA 164,000 LITROS AL AÑO.



LV ALASKA

Blanco

\$ 3.695.00

Lavabo de **sobreponer** sin rebosadero.



Dimensiones:
vista cenital



Dimensiones:
vista lateral

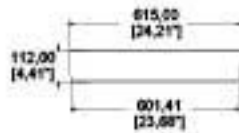

Cerámica al alto brillo, grado de calidad "A" y grueso espesor.

Blanco

LV ANNI

Blanco

\$ 2.091.00

Lavabo de **una perforación** de sobreponer con rebosadero.



Dimensiones:
vista cenital

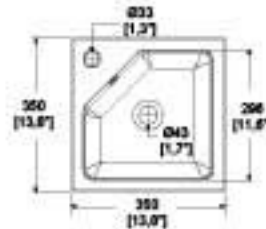

Dimensiones:
vista lateral



Para espacios reducidos.

Cerámica al alto brillo, grado de calidad "A" y grueso espesor.

Blanco

LV NARI

Blanco

\$ 3.695.00

Lavabo de **sobreponer** sin rebosadero.



Dimensiones:
vista cenital



Dimensiones:
vista lateral



Cerámica al alto brillo, grado de calidad "A" y grueso espesor.

Blanco

LV SIRÁ

Blanco

\$ 3.695.00

Lavabo de **sobreponer** sin rebosadero.



Dimensiones:
vista cenital



Dimensiones:
vista lateral

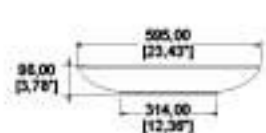

Cerámica al alto brillo, grado de calidad "A" y grueso espesor.

Blanco



LV CASSINI

Blanco

\$ 1.936.00

LV CASSINI M

Marfil

\$ 1.936.00

Lavabo de **sobreponer** sin rebosadero.



Dimensiones
vista cenital

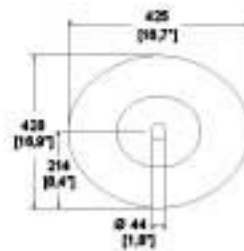

Dimensiones
vista lateral



Cerámica al alto brillo, grado de calidad "A" y grueso espesor.



LV CLAP

Blanco

\$ 2.103.00

Lavabo de **sobreponer** sin rebosadero.



Dimensiones:
vista cenital

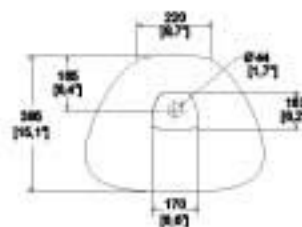

Dimensiones:
vista lateral



Cerámica al alto brillo, grado de calidad "A" y grueso espesor.



LAVABOS DE SOBREPONER

LV FUTURA1

Blanco

\$ 3,695.00

LV FUTURA1 M

Marfil

\$ 3,695.00

Lavabo de una perforación de sobreponer con rebosadero.



Dimensiones:
vista cenital

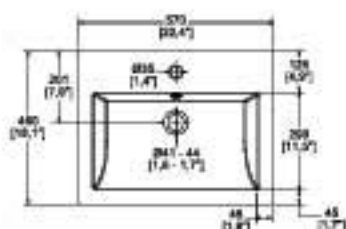

Dimensiones:
vista lateral



Cerámica al alto brillo, grado de calidad "A" y grueso espesor.



Blanco Marfil

LV LUCERNA1

Blanco

\$ 3,695.00

LV LUCERNA1 M

Marfil

\$ 3,695.00

Lavabo de una perforación de sobreponer con rebosadero.



Dimensiones:
vista cenital

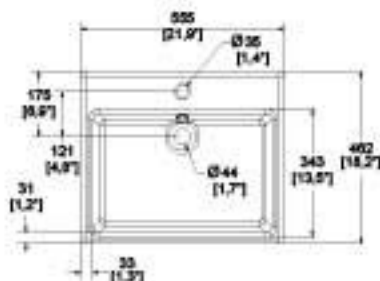

Dimensiones:
vista lateral



Cerámica al alto brillo, grado de calidad "A" y grueso espesor.



Blanco Marfil



ACABADOS



CR
Cromo



EB
Ébano



B
Polar

LV LUCERNA3

Blanco

\$ 3.695.00

LV LUCERNA3 M

Marfil

\$ 3.695.00

Lavabo de **tres perforaciones** de sobreponer con rebosadero.



Dimensiones:
vista cenital

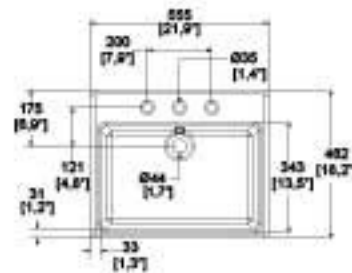

Dimensiones:
vista lateral



Cerámica al alto brillo, grado de calidad "A" y grueso espesor.



Blanco Marfil

LV TRAZZO

Blanco

\$ 2.215.00

LV TRAZZO M

Marfil

\$ 2.215.00

Lavabo de **sobreponer** sin rebosadero



Dimensiones:
vista cenital

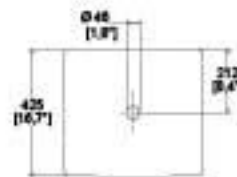

Dimensiones:
vista lateral



Cerámica al alto brillo, grado de calidad "A" y grueso espesor.



Blanco Marfil



LAVABOS DE SOBREPONER

LV MOREA

Blanco

\$ 1.403.00

Lavabo de **sobreponer** sin rebosadero.



Dimensiones:
vista cenital

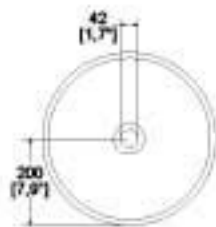

Dimensiones:
vista lateral

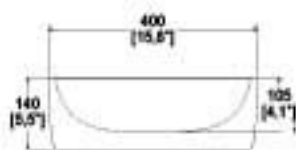

Cerámica al alto brillo, grado de calidad "A" y grueso espesor.

Blanco

LV MOREA1

Blanco

\$ 1.578.00

Lavabo de **una perforación** de sobreponer con rebosadero con **inserto cromado**.



Dimensiones:
vista cenital

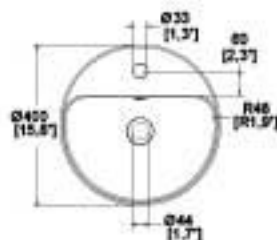

Dimensiones:
vista lateral

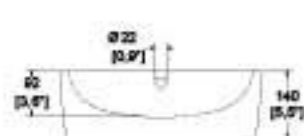

Cerámica al alto brillo, grado de calidad "A" y grueso espesor.

Blanco

LV SANTORINI

Blanco

\$ 1.757.00

Lavabo de **sobreponer** sin rebosadero.



Dimensiones:
vista cenital

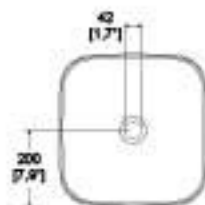

Dimensiones:
vista lateral



Cerámica al alto brillo, grado de calidad "A" y grueso espesor.

Blanco

LV SANTORINI1

Blanco

\$ 2.091.00

Lavabo de **una perforación** de sobreponer con rebosadero con **inserto cromado**.



Dimensiones:
vista cenital

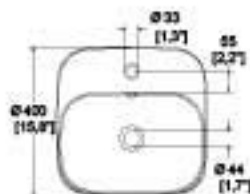

Dimensiones:
vista lateral

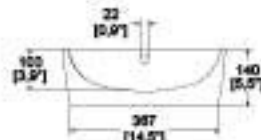

Cerámica al alto brillo, grado de calidad "A" y grueso espesor.

Blanco

LV ELIPSIS

Blanco

\$ 1.403.00

Lavabo de sobrecubierta sin rebosadero.



Dimensiones:
vista cenital



Dimensiones:
vista lateral



Para espacios reducidos

Cerámica al alto brillo, grado de calidad "A" y grueso espesor.

Blanco

LV STALA

Blanco

\$ 2.260.00

Lavabo de doble instalación (sobrepone y sobrecubierta) sin rebosadero.



Dimensiones:
vista cenital

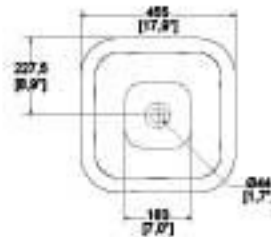

Dimensiones:
vista lateral

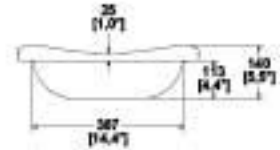

Cerámica al alto brillo, grado de calidad "A" y grueso espesor.

Blanco

LV MARCUS

Blanco

\$ 2.203.00

LV MARCUS M

Marfil

\$ 2.203.00

Lavabo de sobrecubierta con rebosadero.



Dimensiones:
vista cenital

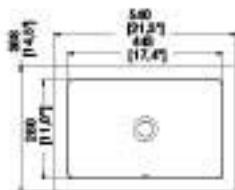

Dimensiones:
vista lateral

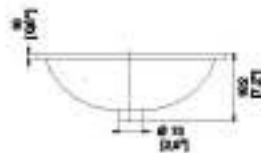

Cerámica al alto brillo, grado de calidad "A" y grueso espesor.

Blanco Marfil



LAVABOS DE BAJOCUBIERTA

LV MARCUS BC

Blanco

\$ 2.385.00

LV MARCUS BC M

Marfil

\$ 2.385.00

Lavabo de bajocubierta con rebosadero.



Dimensiones:
vista cenital

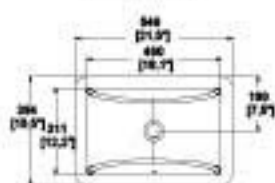

Dimensiones:
vista lateral

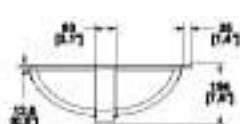

Cerámica al alto brillo, grado de calidad "A" y grueso espesor.



LV LUGANO

Blanco

\$ 1.762.00

Lavabo de bajocubierta con rebosadero.



Dimensiones:
vista cenital

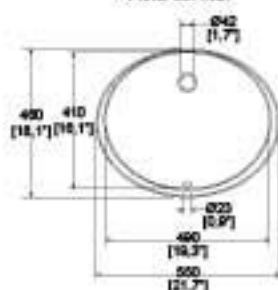

Dimensiones:
vista lateral

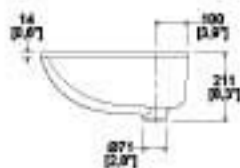

Cerámica al alto brillo, grado de calidad "A" y grueso espesor.





VÁLVULA DE PASO

TV-012

Cromo

\$ 807.00

Válvula de paso
roscable.



Dimensiones:
vista frontal

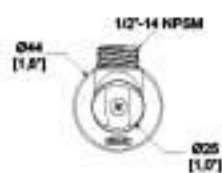

Dimensiones:
vista lateral

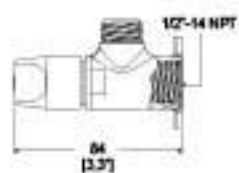

100% latón.
Para instalarse en lavabos, fregaderos y WC.



CR



PAQUETES







INSTITUCIONALES

PAQUETES INSTITUCIONALES



COMBINACIÓN DE
**PRODUCTOS
HELVEX**
LA FÓRMULA PARA UN
**EXCELENTE
DESEMPEÑO**



Visite nuestra página web para consultar y descargar
fichas técnicas e instructivos de instalación.
helvex.com    



PAQUETES INSTITUCIONALES

MÁXIMO AHORRO DE AGUA

3 EN 1

Al adquirir un paquete Helvex puedes obtener hasta TRES PRODUCTOS a precio especial en UNA SOLA CAJA (*en los paquetes 1, 2, 3, 4, 5 y 6 que incluyen fluxómetro, taza y asiento)



Descarga MÁXIMA de:
1 litro por descarga en
mingitorios

3.5 litros por descarga en tazas flux
ÚNICO EN EL MERCADO



INCLUYE ASIENTO

Los paquetes 1, 2, 3, 4, 5 y 6 que
incluyen fluxómetro, taza y asiento



GASTO:
3.2 L a 3.5 L
por accionamiento.
CUMPLE CON LA NORMA:
NOM-002-CONAGUA-2021
NOM-001-SCFI-2018

HELVEX

Garantía de Calidad

FLUXÓMETRO DE MANIJA

1 NAO 1-3.5

PAQUETE

Fluxómetro de manija

110-38-3.5

3.5 litros por descarga

Presión mínima requerida:
2.00 kg/cm²



ASIENTO
AF-1

Taza Nao para fluxómetro
TZF NAO

Incluye asiento. No se aceptan devoluciones de los componentes del paquete por separado. Este producto no entra en otras promociones.

Precio **\$ 8,520.00**



MEZCLADORAS Y MONOMANDOS



Mezcladoras 4".



Mezcladoras
de 8" a 12".







Monomandos
de lavabo.



Monomandos
a pared.



Visite nuestra página web para consultar y descargar
fichas técnicas e instructivos de instalación.
helvex.com    

FLUXÓMETRO DE MANIJA

2 NAO17 1-3.5 
PAQUETE

Fluxómetro de manija
110-38-3.5
3.5 litros por descarga
Presión mínima requerida:
2.00 kg/cm²



Taza Nao para fluxómetro
TZF NAO17 

Incluye asiento. No se aceptan devoluciones de los componentes del paquete por separado. Este producto no entra en otras promociones.

Precio **\$ 8,520.00**

FLUXÓMETRO DE SENSOR DE BATERÍAS

3 NAO FB-3.5
PAQUETE

Fluxómetro de sensor 
FB-110-38-3.5
3.5 litros por descarga
Requiere baterías alcalinas AA
Presión mínima requerida:
2.00 kg/cm²



Taza Nao para fluxómetro
TZF NAO

Incluye asiento. No se aceptan devoluciones de los componentes del paquete por separado. Este producto no entra en otras promociones.

Precio **\$ 14,213.00**

FLUXÓMETRO DE SENSOR
DE BATERÍAS

4 NAO17 FB-3.5

PAQUETE

Fluxómetro de sensor 

FB-110-38-3.5

3.5 litros por descarga

Requiere baterías alcalinas AA

Presión mínima requerida:
2.00 kg/cm²



ASIENTO
AF-1



Taza Nao para fluxómetro

TZF NAO17 

Incluye asiento. No se aceptan devoluciones
de los componentes del paquete por separado.
Este producto no entra en otras promociones.

Precio **\$ 14,213.00**



FLUXÓMETRO DE SENSOR
DE CORRIENTE

5 NAO FC-3.5
PAQUETE

Fluxómetro de sensor 

FC-110-38-3.5
3.5 litros por descarga

Presión mínima requerida:
2.00 kg/cm²



Incluye asiento. No se aceptan devoluciones
de los componentes del paquete por separado.
Este producto no entra en otras promociones.

Precio **\$ 14,213.00**

FLUXÓMETRO DE SENSOR
DE CORRIENTE

6 NAO17 FC-3.5 

PAQUETE

Fluxómetro de sensor 

FC-110-38-3.5

3.5 litros por descarga

Presión mínima requerida:
2.00 kg/cm²



ASIENTO
AF-1



Taza Nao para fluxómetro

TZF NAO17 

Incluye asiento. No se aceptan devoluciones de los componentes del paquete por separado. Este producto no entra en otras promociones.

Precio **\$ 14,213.00**

FLUXÓMETRO
CON MINGITORIO

7 FERRY 1-1

PAQUETE

Fluxómetro de manija

185-19-1

1 litro por descarga

Presión mínima requerida:
1.00 kg/cm²



Mingitorio

MG FERRY

No se aceptan devoluciones de los componentes del paquete por separado. Este producto no entra en otras promociones.

Precio **\$ 9,112.00**

FLUXÓMETRO
CON MINGITORIO

FLUXÓMETRO
CON MINGITORIO

8 FERRY FB-1

PAQUETE

Fluxómetro de sensor
FB-185-19-1 
1 litro por descarga
Requiere baterías alcalinas AA
Presión mínima requerida:
1.00 kg/cm²



Mingitorio
MG FERRY

No se aceptan devoluciones de los componentes del paquete por separado. Este producto no entra en otras promociones.

Precio **\$ 14,746.00**

9 FERRY FC-1

PAQUETE

Fluxómetro de sensor
FC-185-19-1 
1 litro por descarga
Presión mínima requerida:
1.00 kg/cm²



Mingitorio
MG FERRY

No se aceptan devoluciones de los componentes del paquete por separado. Este producto no entra en otras promociones.

Precio **\$ 14,746.00**

TARJETA

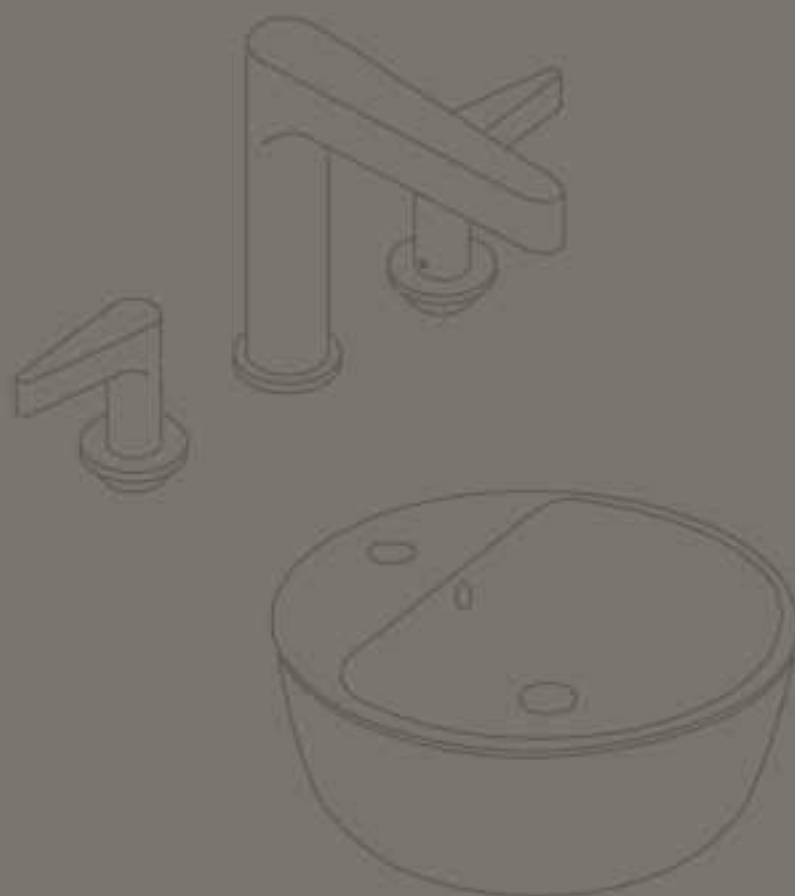

HELVEX

Garantía de Calidad

HELVEX, S.A. DE C.V. Calzada Caltengo #293, Colonia Industrial Vallejo C.P. 02300, Alcaldía Azcapotzalco, Ciudad de México, Tel. (55) 5333-9400 y asistencia técnica al (55) 5333-9431

síguenos    helvex.com

MEZCLADORAS Y MONOMANDOS



Cartucho de disco de cerámica que garantiza un funcionamiento suave y un rendimiento duradero.

Tecnología Airevex que maximiza la mezcla de aire-agua que permite una experiencia agradable y única de lavado ahorrando agua.

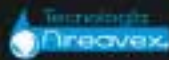

Productos con uso eficiente de agua.

Los manerales tienen una rotación de 90° para abrir, cerrar y regular la temperatura.

Materiales:
-Latón, para mayor durabilidad y confiabilidad.
-Acabados con ultra alta resistencia a la corrosión.

NMX

NMX-C-415-0HNCC-2015 "Industria de la Construcción - Válvulas y Grifos para Agua - Especificaciones y Métodos de ensayo"

*Sólo aplica con productos Ecolvex:
MEP2006-1.9, MID1-S/C-1.9, MID2-S/C-1.9, E907-1.9,
EP99-1.9, E928-1.9, E929-1.9, y EP3003-1.9



Garantía Helvex en acabado cromo de 10 años y resto de acabados 2 años.

Fácil instalación y mantenimiento

TIPOS DE CONTRAS



CONTRA DE PUSH

Presione **LA TAPA** para cerrar la contra y vuelva a **PRESIONAR** para abrirla y dejar drenar **EL AGUA**



CONTRA DE HONGO

El agua drenará alrededor de **LA TAPA**



CONTRA DE REJILLA

El agua drenará a través de **LA REJILLA**

HELVEX

Garantía de Calidad

MEZCLADORAS 4" INCLUYEN MANERALES

ANTARES

HM-14
Cromo

\$ 5.130.00

Mezcladora de lavabo 4".
Incluye contra de rejilla.



Dimensiones
vista frontal

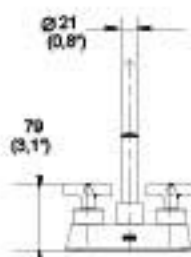

Dimensiones
vista lateral

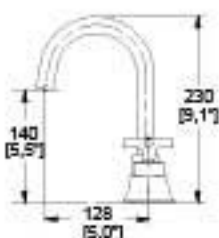

Incluye inserto para usarse con lavabos sin rebosadero.
Presión mínima requerida 0.25 kg/cm².

CR

ALBATROS

HM-17
Cromo

\$ 4.956.00

Mezcladora de lavabo 4".
Incluye contra de rejilla.



Dimensiones:
vista frontal

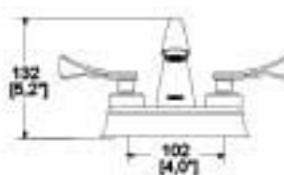

Dimensiones:
vista lateral

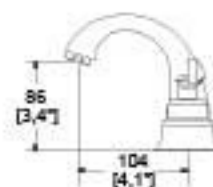

Incluye inserto para usarse con lavabos sin rebosadero.
Presión mínima requerida 0.25 kg/cm².

CR

ANTEA

HM-18
Cromo

\$ 4.894.00

Mezcladora de lavabo 4".
Incluye contra de rejilla.



Dimensiones
vista frontal

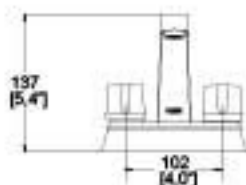

Dimensiones
vista lateral

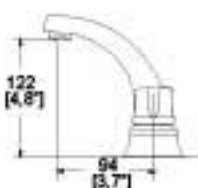

Incluye inserto para usarse con lavabos sin rebosadero.
Presión mínima requerida 0.25 kg/cm².

CR

ÁTICA

HM-21
Cromo

\$ 5.130.00

Mezcladora de lavabo 4".
Incluye contra de rejilla.



Dimensiones:
vista frontal

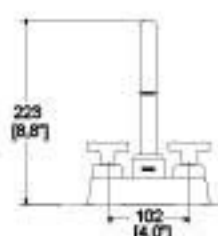

Dimensiones:
vista lateral

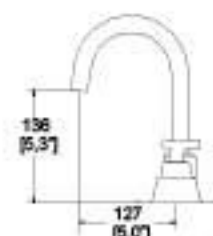

Incluye inserto para usarse con lavabos sin rebosadero.
Presión mínima requerida 0.25 kg/cm².

CR

ACAYA

HM-22

Cromo

\$ 4,894.00

Mezcladora de lavabo 4".
Incluye contra de rejilla.



Dimensiones:
vista frontal

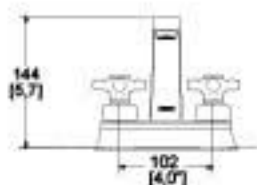

Dimensiones:
vista lateral

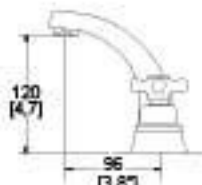

Incluye inserto para usarse con lavabos sin rebosadero.
Presión mínima requerida 0.25 kg/cm².



ELITE

MI-01-S/C

Cromo

\$ 3,577.00

Mezcladora de lavabo 4".
No incluye contra.



Dimensiones:
vista frontal

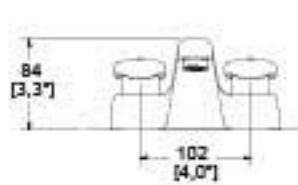

Dimensiones:
vista lateral

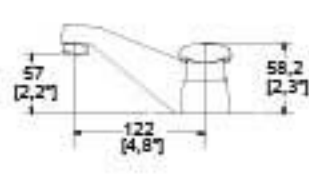

Presión mínima requerida 0.25 kg/cm².

NMX NMX-C-415-0NNCCE-2015



PRIMMA

MI-02-S/C

Cromo

\$ 4,051.00

Mezcladora de lavabo 4".
No incluye contra.



Dimensiones:
vista frontal

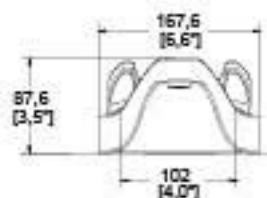

Dimensiones:
vista lateral

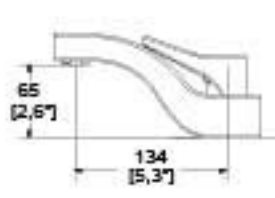

Presión mínima requerida 0.25 kg/cm².

NMX NMX-C-415-0NNCCE-2015



MEZCLADORAS 8" a 12" INCLUYEN MANERALES

IGUAZÚ

MEP-2004

Cromo

\$ 6,436.00

Mezcladora de lavabo
8" a 12".
Incluye contra de push.



Dimensiones:
vista frontal

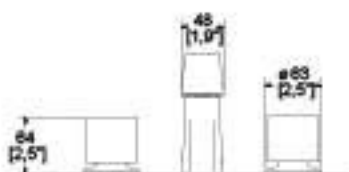

Dimensiones:
vista lateral

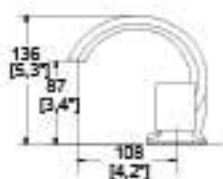

Incluye inserto para usarse con lavabos sin rebosadero.
Presión mínima requerida 0.25 kg/cm².



CR

NUVA

MEP-2006

Cromo

\$ 10,394.00

Mezcladora de lavabo
8" a 12".
Incluye contra de push.



Modelo ahorrador
MEP2006-1.9



Dimensiones:
vista frontal

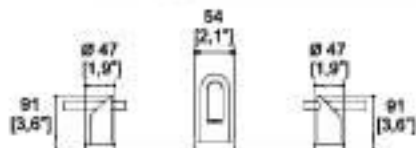

Dimensiones:
vista lateral

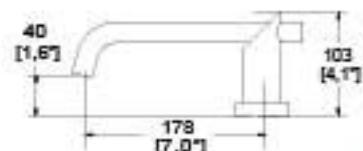

Incluye inserto para usarse con lavabos sin rebosadero.
Presión mínima requerida 0.25 kg/cm².

NMX NMX-C-415-ONNCC-2015



CR

PREMIER

MEP-2115

Cromo

\$ 11,225.00

Mezcladora de lavabo
8" a 12".
Incluye contra de push.



Dimensiones:
vista frontal

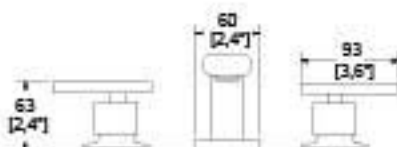

Dimensiones:
vista lateral

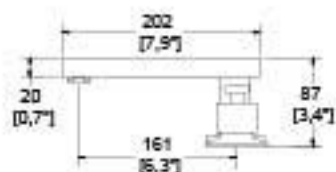

Incluye inserto para usarse con lavabos sin rebosadero.
Presión mínima requerida 0.25 kg/cm².



CR

VÉRTIKA

MP-1000

Cromo

\$ 11,753.00

Mezcladora de lavabo
8" a 12".
Incluye contra de push.



Dimensiones:
vista frontal

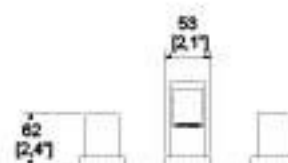

Dimensiones:
vista lateral

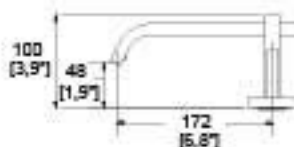

Incluye inserto para usarse con lavabos sin rebosadero.
Presión mínima requerida 1.00 kg/cm².
Consumo de agua mínimo de 6 L/min.



CR

KONOS

M-1004

Cromo

\$ 11.038.00

Mezcladora de lavabo
8" a 12".
Incluye contra de push.



Dimensiones:
vista frontal

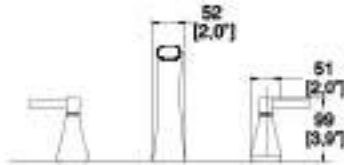

Dimensiones:
vista lateral

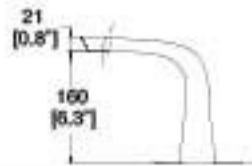

Incluye inserto para usarse con lavabos sin rebosadero.
Presión mínima requerida 0.25 kg/cm².

CR

CLÁSICA

M-1005

Cromo

\$ 7.904.00

Mezcladora de lavabo
8" a 12".
Incluye contra de push.



Dimensiones:
vista frontal

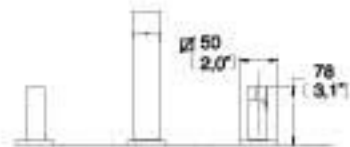

Dimensiones:
vista lateral

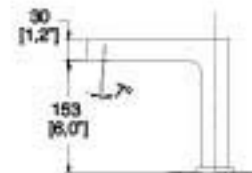

Incluye inserto para usarse con lavabos sin rebosadero.
Presión mínima requerida 0.25 kg/cm².

CR

NAUTILIA

M-1006

Cromo

\$ 11.081.00

Mezcladora de lavabo
8" a 12".
Incluye contra de push.



Dimensiones:
vista frontal

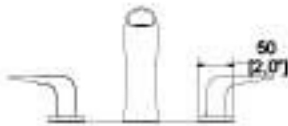

Dimensiones:
vista lateral

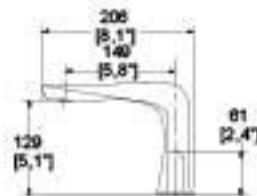

Incluye inserto para usarse con lavabos sin rebosadero.
Presión mínima requerida 0.25 kg/cm².

CR



MONOMANDOS DE LAVABO

KONOS

E-916
Cromo

\$7,030.00

Monomando de lavabo.
Incluye contra de push.

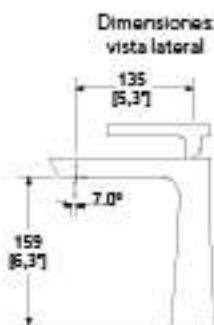
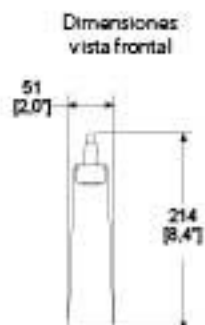

Incluye inserto para usarse con lavabos sin rebosadero.
Presión mínima requerida 0.40 kg/cm².

CR

CLÁSICA

E-917
Cromo

\$ 6,043.00

Monomando de lavabo.
Incluye contra de push.

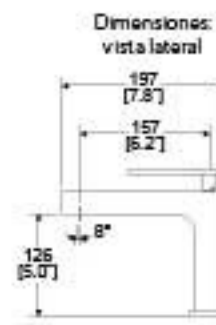
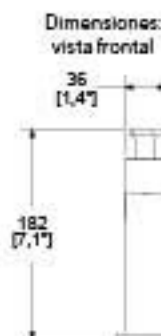

Maneral reforzado.
Incluye inserto para usarse con lavabos sin rebosadero.
Presión mínima requerida 0.40 kg/cm².

CR

CENTURY

E-928
Cromo

\$ 5,269.00

Monomando de lavabo.
Incluye contra de rejilla.

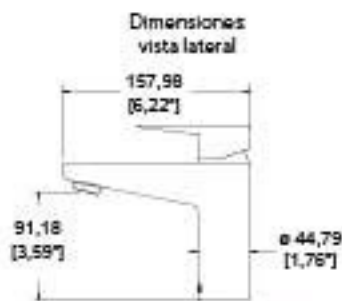

Incluye inserto para usarse con lavabos sin rebosadero.
Presión mínima requerida 0.25 kg/cm².

CR

NMX NMX-C-415-ONNCCCE-2015

CENTURY alto

E-943
Cromo

\$ 6,898.00

Monomando de lavabo.
Incluye contra de rejilla.

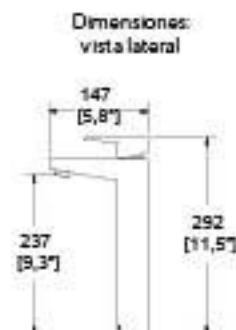
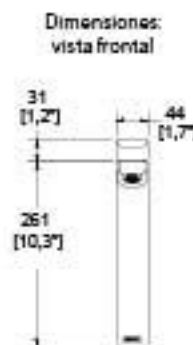

Incluye inserto para usarse con lavabos sin rebosadero.
Presión mínima requerida 0.60 kg/cm².

CR

Todos nuestros monomandos cuentan con Tecnología Aireavox



ÁLIKA

E-920

Cromo

\$ 8.447.00

Monomando de lavabo.
Incluye contra de push.



Dimensiones:
vista frontal

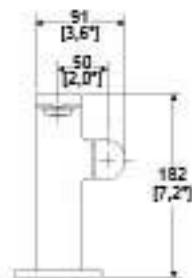

Dimensiones:
vista lateral

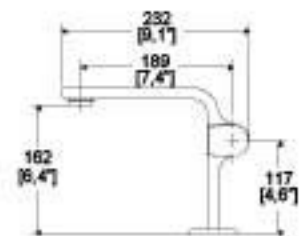

Incluye inserto para usarse con lavabos sin rebosadero.
Presión mínima requerida 0.60 kg/cm².

CR

ÁLIKA alto

E-921

Cromo

\$ 10.586.00

Monomando de lavabo.
Incluye contra de push.



Dimensiones:
vista frontal

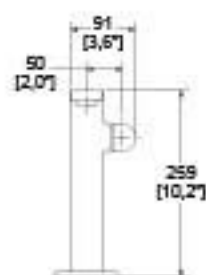

Dimensiones:
vista lateral

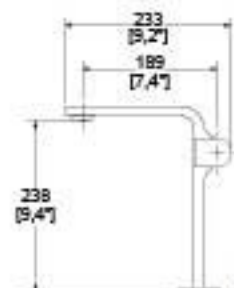

Incluye inserto para usarse con lavabos sin rebosadero.
Presión mínima requerida 0.60 kg/cm².

CR

Todos nuestros monomandos
cuentan con Tecnología Airavox



BAMBOO

E-922

Cromo

\$ 8.038.00

Monomando de lavabo.
Incluye contra de push.



CR

Incluye inserto para usarse con lavabos sin rebosadero.
Presión mínima requerida 0.80 kg/cm².
Con un solo movimiento controlas flujo y temperatura.

BAMBOO

E-922-B

Polar

\$ 9.243.00

Monomando de lavabo.
Incluye contra de push polar.



B

Incluye inserto para usarse con lavabos sin rebosadero.
Presión mínima requerida 0.80 kg/cm².
Con un solo movimiento controlas flujo y temperatura.

BAMBOO

E-922-EB

Ébano

\$ 9.243.00

Monomando de lavabo.
Incluye contra de push ébano.



EB

Incluye inserto para usarse con lavabos sin rebosadero.
Presión mínima requerida 0.80 kg/cm².
Con un solo movimiento controlas flujo y temperatura.

Dimensiones:
vista frontal



Dimensiones:
vista lateral

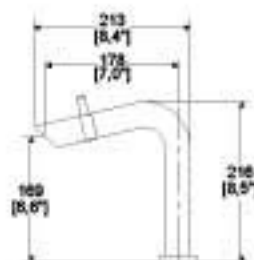

Todos nuestros monomandos cuentan con Tecnología Aire avex



BAMBOO

E-923

Cromo

\$ 9,387.00

Monomando de lavabo.
Incluye contra de push.



CR

Incluye inserto para usarse con lavabos sin rebosadero.
Presión mínima requerida 0.80 kg/cm².
Con un solo movimiento controlas flujo y temperatura.

BAMBOO

E-923-B

Polar

\$ 10,796.00

Monomando de lavabo.
Incluye contra de push polar.



B

Incluye inserto para usarse con lavabos sin rebosadero.
Presión mínima requerida 0.80 kg/cm².
Con un solo movimiento controlas flujo y temperatura.

BAMBOO

E-923-EB

Ébano

\$ 10,796.00

Monomando de lavabo.
Incluye contra de push ébano.



EB

Incluye inserto para usarse con lavabos sin rebosadero.
Presión mínima requerida 0.80 kg/cm².
Con un solo movimiento controlas flujo y temperatura.

Dimensiones:
vista frontal



Dimensiones:
vista lateral

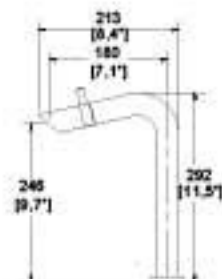

Todos nuestros monomandos
cuentan con Tecnología Aireavox:





SCALA

E-948

Cromo

\$7,670.00

Monomando de lavabo.
Incluye contra de push.



MANERAL
DE INSTALACIÓN
INDEPENDIENTE

Incluye inserto para usarse con lavabos sin rebosadero.
Presión mínima requerida 0.60 kg/cm².



CR

SCALA alto

E-949

Cromo

\$ 8,922.00

Monomando de lavabo.
Incluye contra de push.



MANERAL
DE INSTALACIÓN
INDEPENDIENTE

Incluye inserto para usarse con lavabos sin rebosadero.
Presión mínima requerida 0.60 kg/cm².



CR

SCALA

E-948-EB

Ébano

\$ 8,821.00

Monomando de lavabo.
Incluye contra de push ébano.



MANERAL
DE INSTALACIÓN
INDEPENDIENTE

Incluye inserto para usarse con lavabos sin rebosadero.
Presión mínima requerida 0.60 kg/cm².



EB

SCALA alto

E-949-EB

Ébano

\$ 10,259.00

Monomando de lavabo.
Incluye contra de push ébano.



MANERAL
DE INSTALACIÓN
INDEPENDIENTE

Incluye inserto para usarse con lavabos sin rebosadero.
Presión mínima requerida 0.60 kg/cm².



EB

Dimensiones:
vista frontal

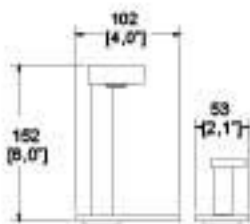

Dimensiones:
vista lateral

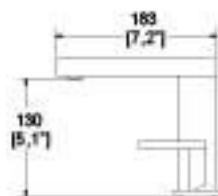

Dimensiones:
vista frontal

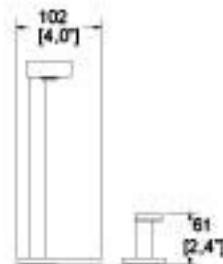

Dimensiones:
vista lateral

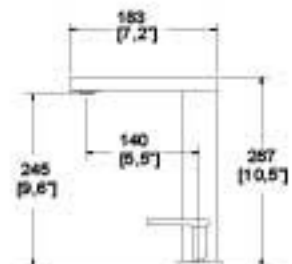

Todos nuestros monomandos
cuentan con Tecnología Aireavox:



MONOMANDOS DE LAVABO

INDUS

E-950-EB

Ébano

\$ 9,243.00

Monomando de lavabo.
Incluye contra de push ébano.



Dimensiones
vista frontal

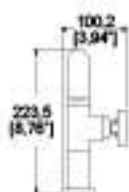

Dimensiones
vista lateral

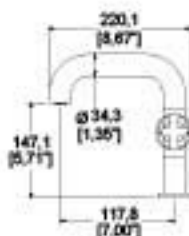

Incluye inserto para usarse con lavabos sin rebosadero.
Presión mínima requerida 0.60 kg/cm².

EB

INDUS alto

E-951-EB

Ébano

\$ 10,796.00

Monomando de lavabo.
Incluye contra de push ébano.



Dimensiones:
vista frontal

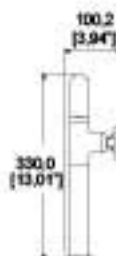

Dimensiones:
vista lateral

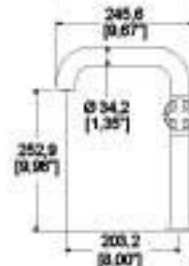

Incluye inserto para usarse con lavabos sin rebosadero.
Presión mínima requerida 0.60 kg/cm².

EB

VÉRTIKA

EP-905

Cromo

\$ 9,308.00

Monomando de lavabo.
Incluye contra de push.



Dimensiones
vista frontal

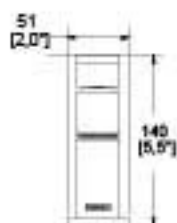

Dimensiones
vista lateral

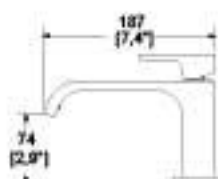

Incluye inserto para usarse con lavabos sin rebosadero.
Presión mínima requerida 0.60 kg/cm².

CR

EXTENSIÓN

THP-968

Cromo

\$ 2,267.00

Extensión de 17 cm
para monomando de
lavabo Vértika
modelo EP-905.



Dimensiones:
vista frontal



Acabado.

CR

Todos nuestros monomandos
cuentan con Tecnología Air avex



NUVA
EP-99
Cromo

\$ 9,674.00

Monomando de lavabo.
Incluye contra de push.



Dimensiones:
vista frontal

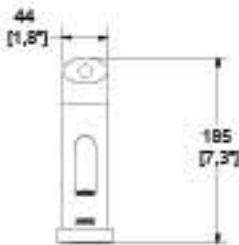

Dimensiones:
vista lateral

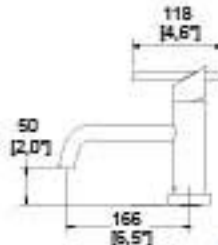

Incluye inserto para usarse con lavabos sin rebosadero.
Presión mínima requerida 0.25 kg/cm².

NMX NMX-C-415-0NNCCE-2015

CR

NUVA mediano
EP-945
Cromo

\$ 11,655.00

Monomando de lavabo.
Incluye contra de push.



Dimensiones:
vista frontal



Dimensiones:
vista lateral

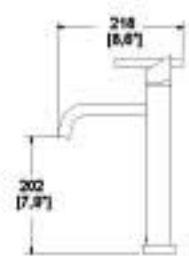

Incluye inserto para usarse con lavabos sin rebosadero.
Presión mínima requerida 0.25 kg/cm².

CR

NUVA alto
EP-947
Cromo

\$ 11,964.00

Monomando de lavabo.
Incluye contra de push.



Dimensiones:
vista frontal

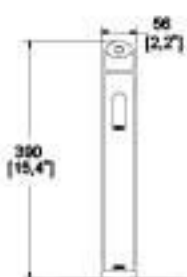

Dimensiones:
vista lateral

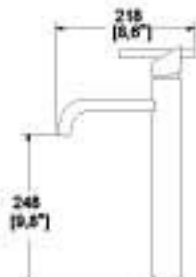

Incluye inserto para usarse con lavabos sin rebosadero.
Presión mínima requerida 0.25 kg/cm².

CR

Todos nuestros monomandos cuentan con Tecnología Airavox



MONOMANDOS DE LAVABO

PREMIER

EP-909

Cromo

\$ 7.099.00

Monomando de lavabo.
Incluye contra de push.



Incluye inserto para usarse con lavabos sin rebosadero.
Presión mínima requerida 0,60 kg/cm².



CR

PREMIER

EP-909-EB

Ébano

\$ 8.162.00

Monomando de lavabo.
Incluye contra de push ébano.



Incluye inserto para usarse con lavabos sin rebosadero.
Presión mínima requerida 0,60 kg/cm².



EB

Dimensiones:
vista frontal

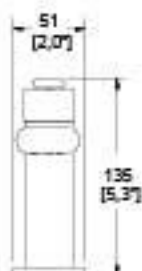

Dimensiones:
vista lateral

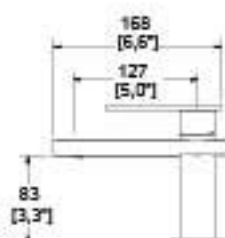

Todos nuestros monomandos cuentan con Tecnología Air avax





PREMIER alto
EP-938
Cromo

\$ 9.122.00

Monomando de lavabo.
Incluye contra de push.



Incluye inserto para usarse con lavabos sin rebosadero.
Presión mínima requerida 0.70 kg/cm².



PREMIER alto
EP-938-EB
Ébano

\$ 10.489.00

Monomando de lavabo.
Incluye contra de push ébano.



Incluye inserto para usarse con lavabos sin rebosadero.
Presión mínima requerida 0.70 kg/cm².



Dimensiones:
vista frontal



Dimensiones:
vista lateral

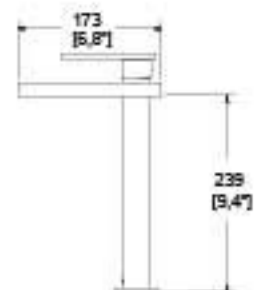

Todos nuestros monomandos
cuentan con Tecnología Airoavax



MONOMANDOS DE LAVABO

PREMIER II

E-941

Cromo

\$ 6,518.00

Monomando de lavabo.
Incluye contra de push.



Incluye inserto para usarse con lavabos sin rebosadero.
Presión mínima requerida 0,60 kg/cm².



CR

PREMIER II

E-941-EB

Ébano

\$ 7,497.00

Monomando de lavabo.
Incluye contra de push ébano.



Incluye inserto para usarse con lavabos sin rebosadero.
Presión mínima requerida 0,60 kg/cm².



EB

Dimensiones:
vista frontal

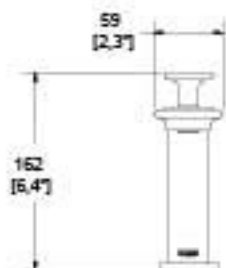

Dimensiones:
vista lateral

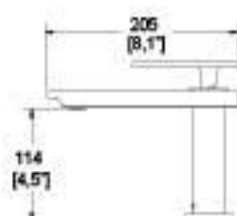

Todos nuestros monomandos cuentan con Tecnología Air avax



SQUADRA

E-929
Cromo

\$ 5,436.00

Monomando de lavabo.
Incluye contra de rejilla.

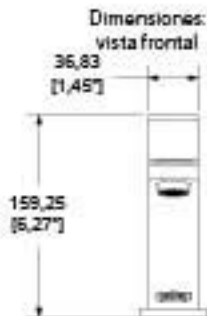

Incluye inserto para usarse con lavabos sin rebosadero.
Presión mínima requerida 0.40 kg/cm².

NMX NMX-C-415-0NNCCE-2015

CR

SQUADRA alto

E-937
Cromo

\$ 7,520.00

Monomando de lavabo.
Incluye contra de rejilla.



Presión mínima requerida 0.40 kg/cm².

CR

KÚBICA

EP-94
Cromo

\$ 10,161.00

Monomando de lavabo.
Incluye contra de push.

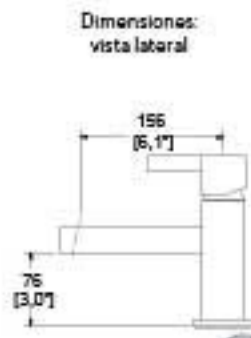
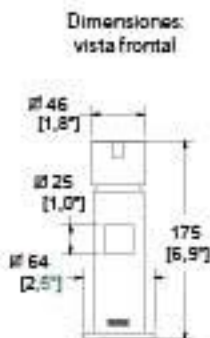

Incluye inserto para usarse con lavabos sin rebosadero.
Presión mínima requerida 0.25 kg/cm².

CR

NOVARA

E-930
Cromo

\$ 7,220.00

Monomando de lavabo.
Incluye contra de push.

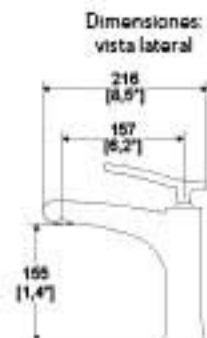
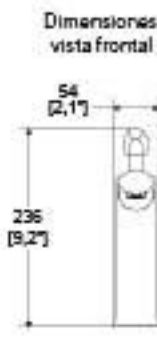

Incluye inserto para usarse con lavabos sin rebosadero.
Presión mínima requerida 0.25 kg/cm².

CR

Todos nuestros monomandos
cuentan con Tecnología Airavex



NAUTILIA

E-924

Cromo

\$ 8.447.00

Monomando de lavabo.
Incluye contra de push.

MANERAL
DE REGULACIÓN
INDEPENDIENTE



Dimensiones
vista frontal

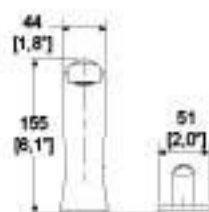

Dimensiones
vista lateral

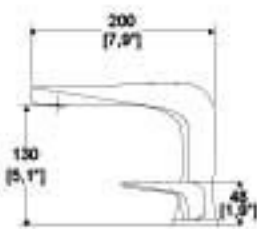

Incluye inserto para usarse con lavabos sin rebosadero.
Presión mínima requerida 0.70 kg/cm².



CR

NAUTILIA

E-925

Cromo

\$ 9.852.00

Monomando de lavabo.
Incluye contra de push.

MANERAL
DE REGULACIÓN
INDEPENDIENTE



Dimensiones
vista frontal

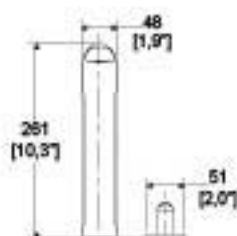

Dimensiones
vista lateral

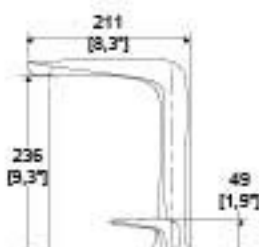

Incluye inserto para usarse con lavabos sin rebosadero.
Presión mínima requerida 0.70 kg/cm².



CR



Todos nuestros monomandos
cuentan con Tecnología Airsavex

EXPLORA

E-907
Cromo

\$ 5,561.00

Monomando de lavabo.
Incluye contra de rejilla.



Incluye inserto para usarse con lavabos sin rebosadero.
Presión mínima requerida 0.25 kg/cm².

NMX NMX-C-415-0NMCCE-2015

EXPLORA

E-907-CE
Cromo

\$ 5,561.00

Monomando de lavabo.
Incluye contra de rejilla.



Incluye inserto para usarse con lavabos sin rebosadero.
Cartucho ecológico.
Ahorro de agua y energía.
Presión mínima recomendada 0.60 kg/cm².

EXPLORA

E-908
Cromo

\$ 5,158.00

Monomando de lavabo.
No incluye contra.



Presión mínima requerida 0.25 kg/cm².

EXPLORA

E-908-CE
Cromo

\$ 5,158.00

Monomando de lavabo.
No incluye contra.



Cartucho ecológico.
Ahorro de agua y energía.
Presión mínima recomendada 0.60 kg/cm².

Dimensiones:
vista frontal



Dimensiones:
vista lateral

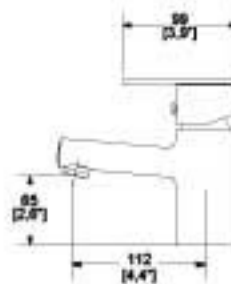

Todos nuestros monomandos cuentan con Tecnología Airevax



FUNCIONAMIENTO DEL CARTUCHO ECOLÓGICO

PARA LOS MODELOS
E-907-CE Y E-908-CE

1 Ahorro de agua

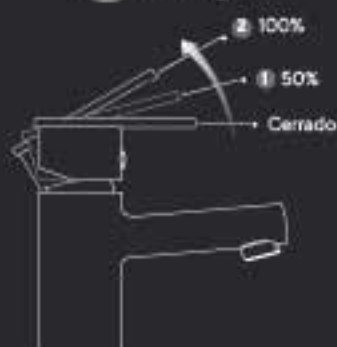

2 Ahorro de energía

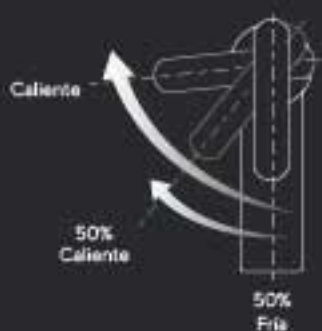

MÁXIMA mediano
EP-932

Cromo

\$7,304.00

Monomando de lavabo.
Incluye contra de push.



Incluye inserto para usarse con lavabos sin rebosadero.
Presión mínima requerida 0.25 kg/cm².

CR

MÁXIMA alto
EP-933

Cromo

\$8,652.00

Monomando de lavabo.
Incluye contra de push.



Incluye inserto para usarse con lavabos sin rebosadero.
Presión mínima requerida 0.25 kg/cm².

CR

MÁXIMA mediano
EP-932-EB

Ébano

\$8,400.00

Monomando de lavabo.
Incluye contra de push ébano.



Incluye inserto para usarse con lavabos sin rebosadero.
Presión mínima requerida 0.25 kg/cm².

EB

MÁXIMA alto
EP-933-EB

Ébano

\$9,950.00

Monomando de lavabo.
Incluye contra de push ébano.



Incluye inserto para usarse con lavabos sin rebosadero.
Presión mínima requerida 0.25 kg/cm².

EB

Dimensiones:
vista frontal

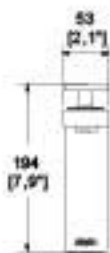

Dimensiones:
vista lateral

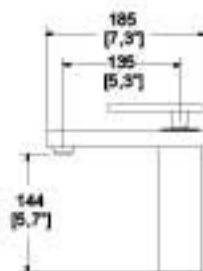

Dimensiones:
vista frontal



Dimensiones:
vista lateral

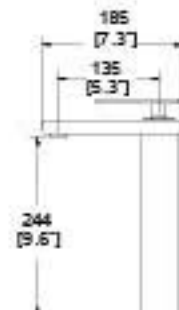

Todos nuestros monomandos cuentan con Tecnología Airavox



MONOMANDOS DE LAVABO

LAND

E-939

Cromo

\$ 6,043.00

Monomando de lavabo.
Incluye contra de push.



Incluye inserto para usarse con lavabos sin rebosadero.
Presión mínima requerida 0.40 kg/cm².

CR

LAND

E-939-EB

Ébano

\$ 6,949.00

Monomando de lavabo.
Incluye contra de push ébano.



Incluye inserto para usarse con lavabos sin rebosadero.
Presión mínima requerida 0.40 kg/cm².

EB

Dimensiones:
vista frontal

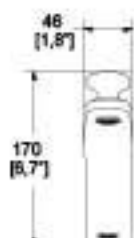

Dimensiones:
vista lateral

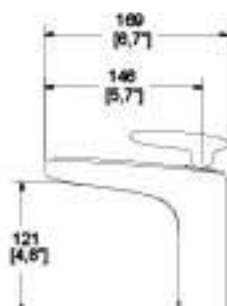

Todos nuestros monomandos cuentan con Tecnología Aireavex.



ALBA

E-940
Cromo

\$ 8.038.00

Monomando de lavabo.
Incluye contra de push.



Dimensiones:
vista frontal



Dimensiones:
vista lateral



Incluye inserto para usarse con lavabos sin rebosadero.
Presión mínima requerida 0.40 kg/cm².

CR

LUSITANIA

LUS-100
Cromo

\$ 3.039.00

Monomando de lavabo.
No incluye contra.



Dimensiones:
vista frontal

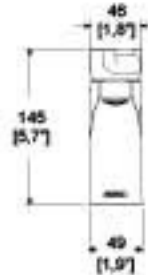

Dimensiones:
vista lateral

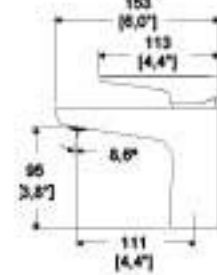

Maneral marcado con indicador de temperatura
frio o caliente.
Presión mínima requerida 0.25 kg/cm².

CR

LUSITANIA alto

LUS-101
Cromo

\$ 4.132.00

Monomando de lavabo.
No incluye contra.



Dimensiones
vista frontal

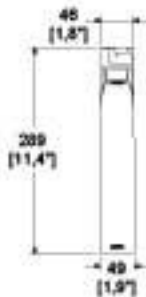

Dimensiones:
vista lateral

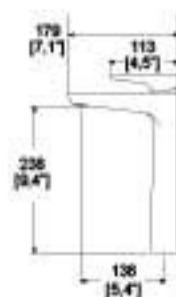

Maneral marcado con indicador de temperatura
frio o caliente.
Presión mínima requerida 0.25 kg/cm².

CR



Todos nuestros monomandos
cuentan con Tecnología Air avex



MONOMANDOS DE LAVABO

PIAZZA

PIA-100

Cromo

\$ 3,039.00

Monomando de lavabo.
No incluye contra.



Maneral marcado con indicador de temperatura
frio o caliente.
Presión mínima requerida 0.25 kg/cm².



CR

PIAZZA alto

PIA-101

Cromo

\$ 4,132.00

Monomando de lavabo.
No incluye contra.



Maneral marcado con indicador de temperatura
frio o caliente.
Presión mínima requerida 0.25 kg/cm².



CR

PIAZZA

PIA-100-EB

Ébano

\$ 3,495.00

Monomando de lavabo.
No incluye contra.



Presión mínima requerida 0.25 kg/cm².



EB

PIAZZA alto

PIA-101-EB

Ébano

\$ 4,752.00

Monomando de lavabo.
No incluye contra.



Presión mínima requerida 0.25 kg/cm².



EB

Dimensiones:
vista frontal

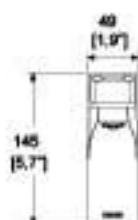

Dimensiones:
vista lateral

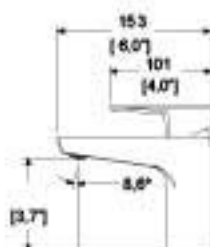

Dimensiones:
vista frontal



Dimensiones:
vista lateral



Todos nuestros monomandos
cuentan con Tecnología Air avex





MONOMANDOS DE LAVABO

PIURA

PIU-100

Cromo

\$ 10.795.00

Monomando de lavabo.
Incluye contra de push.



Dimensiones
vista frontal

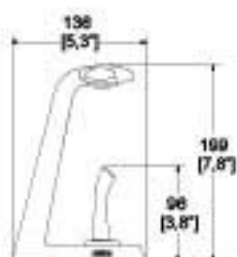

Dimensiones
vista lateral

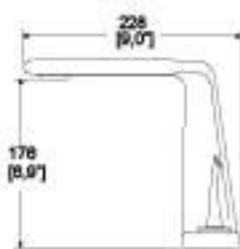

Incluye inserto para usarse con lavabos sin rebosadero.
Presión mínima requerida 0.60 kg/cm².

CR

PIURA alto

PIU-101

Cromo

\$ 13.597.00

Monomando de lavabo.
Incluye contra de push.

MANERA
DE INSTALACIÓN
RECOMENDADA



Dimensiones
vista frontal

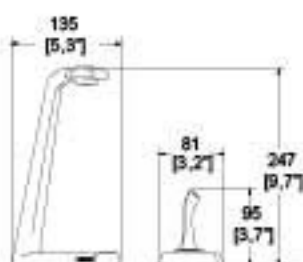

Dimensiones
vista lateral

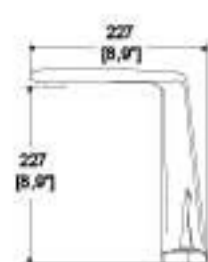

Incluye inserto para usarse con lavabos sin rebosadero.
Presión mínima requerida 0.60 kg/cm².

CR



Todos nuestros monomandos
cuentan con Tecnología Aireavex



NUVA
EP-3003
Cromo

\$ 10,343.00

Monomando de lavabo a pared.
Incluye contra de push.



Dimensiones:
vista frontal

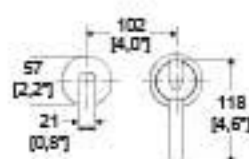

Dimensiones:
vista lateral

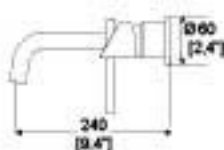

Incluye inserto para usarse con lavabos sin rebosadero.
Presión mínima requerida 0.25 kg/cm².

NMX NMX-C-415-0NNCCE-2015



KÚBICA
EP-3005
Cromo

\$ 12,308.00

Monomando de lavabo a pared.
Incluye contra de push.



Dimensiones:
vista frontal

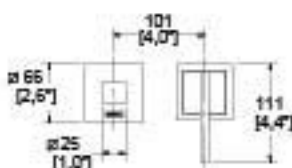

Dimensiones:
vista lateral

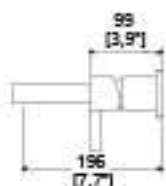

Incluye inserto para usarse con lavabos sin rebosadero.
Presión mínima requerida 0.25 kg/cm².



VÉRTIKA
EP-3007
Cromo

\$ 11,015.00

Monomando de lavabo a pared.
Incluye contra de push.



Incluye inserto para usarse con lavabos sin rebosadero.
Presión mínima requerida 1.00 kg/cm².
Consumo de agua: 5 L/min.



VÉRTIKA
EP-3007-EB
Ébano

\$ 12,667.00

Monomando de lavabo a pared.
Incluye contra de push ébano.



Incluye inserto para usarse con lavabos sin rebosadero.
Presión mínima requerida 1.00 kg/cm².
Consumo de agua: 5 L/min.



Dimensiones:
vista frontal

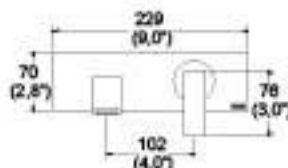

Dimensiones:
vista lateral

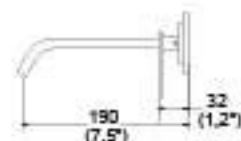

Todos nuestros monomandos cuentan con Tecnología Aireavax





ACABADOS



CR

Cromo



EB

Ébano

CONTRAS Y COMPLEMENTOS PARA LAVABO



Céspedes.



Contras de rejilla.



Contras de hongo.



Contras de push.



Tubo de extensión.



Válvula de paso.



CONTRAS Y COMPLEMENTOS PARA LAVABO

TIPOS DE CONTRAS



CONTRA DE PUSH

Presione LA TAPA para cerrar la contra y vuelva a PRESIONAR para abrirla y dejar drenar EL AGUA.



CONTRA DE HONGO

El agua drenará alrededor de LA TAPA.



CONTRA DE REJILLA

El agua drenará a través de LA REJILLA.

cúpula fija
con rejilla



HELVEX

Garantía de Calidad



Garantía Helvex en acabado cromo de 10 años
y resto de acabados 2 años.

CONTRAS Y COMPLEMENTOS PARA LAVABO

TH-058

Cromo

\$ 1.504,00

Contra con rejilla para lavabo con rebosadero.



Dimensiones:
vista cenital



Dimensiones:
vista lateral

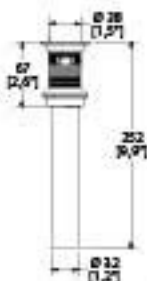

Acabado.

CR

TH-059

Cromo

\$ 1.504,00

Contra con rejilla para lavabo sin rebosadero.



Dimensiones:
vista cenital



Dimensiones:
vista lateral

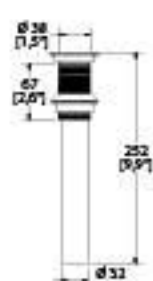

Acabado.

CR

TH-062

Cromo

\$ 1.454,00

Contra tipo hongo para lavabo con rebosadero.



Dimensiones:
vista cenital

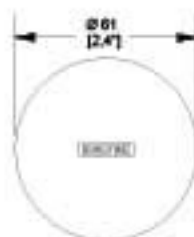

Dimensiones:
vista lateral

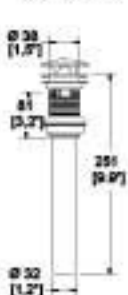

Acabado.

CR

TH-063

Cromo

\$ 1.454,00

Contra tipo hongo para lavabo sin rebosadero.



Dimensiones:
vista cenital



Dimensiones:
vista lateral

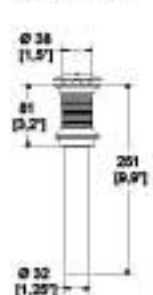

Acabado.

CR

TH-064

Cromo

\$ 1.742.00

Contra de push para lavabo con rebosadero.



Acabado.



CR

TH-065

Cromo

\$ 1.742.00

Contra de push para lavabo sin rebosadero.



Acabado.



CR

TH-064-EB

Ébano

\$ 2.003.00

Contra de push para lavabo con rebosadero.



Acabado.



EB

TH-065-EB

Ébano

\$ 2.003.00

Contra de push para lavabo sin rebosadero.



Acabado.



EB

Dimensiones:
vista cenital



Dimensiones:
vista cenital

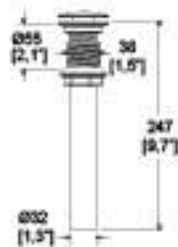

Dimensiones:
vista frontal



Dimensiones:
vista lateral

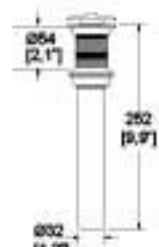

TH-001

Cromo

\$ 590.00

Tubo extensión de **37 cm** para contra de lavabo.



Dimensiones



Acabado:



CR

TV-012

Cromo

\$ 807.00

Válvula de paso roscable.



Dimensiones:
vista frontal



Dimensiones:
vista lateral

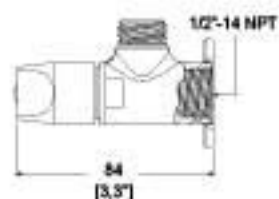

Acabado 100% latón
Para instalarse en lavabos, fregaderos y WC.



CR



TV-016

Cromo

\$ 1,725.00

Césped para lavabo con registro.
No incluye contra.



Acabado.

CR

TV-016-40

Cromo

\$ 2,163.00

Césped para lavabo de 40 cm de largo con registro.
No incluye contra.



Acabado.

CR

TV-016-EB

Ébano

\$ 1,984.00

Césped para lavabo con registro.
No incluye contra.



Acabado.

EB

TV-016-40-EB

Ébano

\$ 2,487.00

Césped para lavabo de 40 cm de largo con registro.
No incluye contra.



Acabado.

EB

Dimensiones:
vista frontal

Dimensiones:
vista lateral

Dimensiones:
vista frontal

Dimensiones:
vista lateral

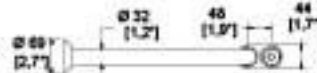
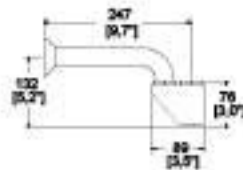
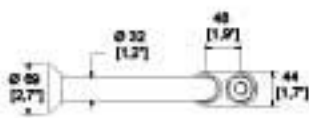

CÉSPOL PARA LAVABO

TV-017

Cromo

\$ 1.999.00

Céspol para lavabo con registro.
No incluye contra.



Acabado.

CR

TV-017-40

Cromo

\$ 2.295.00

Céspol para lavabo de 40 cm de largo con registro.
No incluye contra.



Acabado.

CR

TV-017-EB

Ébano

\$ 2.299.00

Céspol para lavabo con registro.
No incluye contra.



Acabado.

EB

TV-017-40-EB

Ébano

\$ 2.639.00

Céspol para lavabo de 40 cm de largo con registro.
No incluye contra.



Acabado.

EB

Dimensiones:
vista frontal

Dimensiones:
vista lateral

Dimensiones:
vista frontal

Dimensiones:
vista lateral

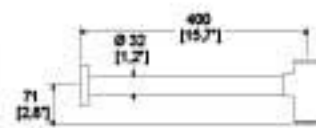
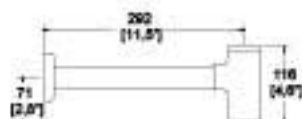

ACABADOS

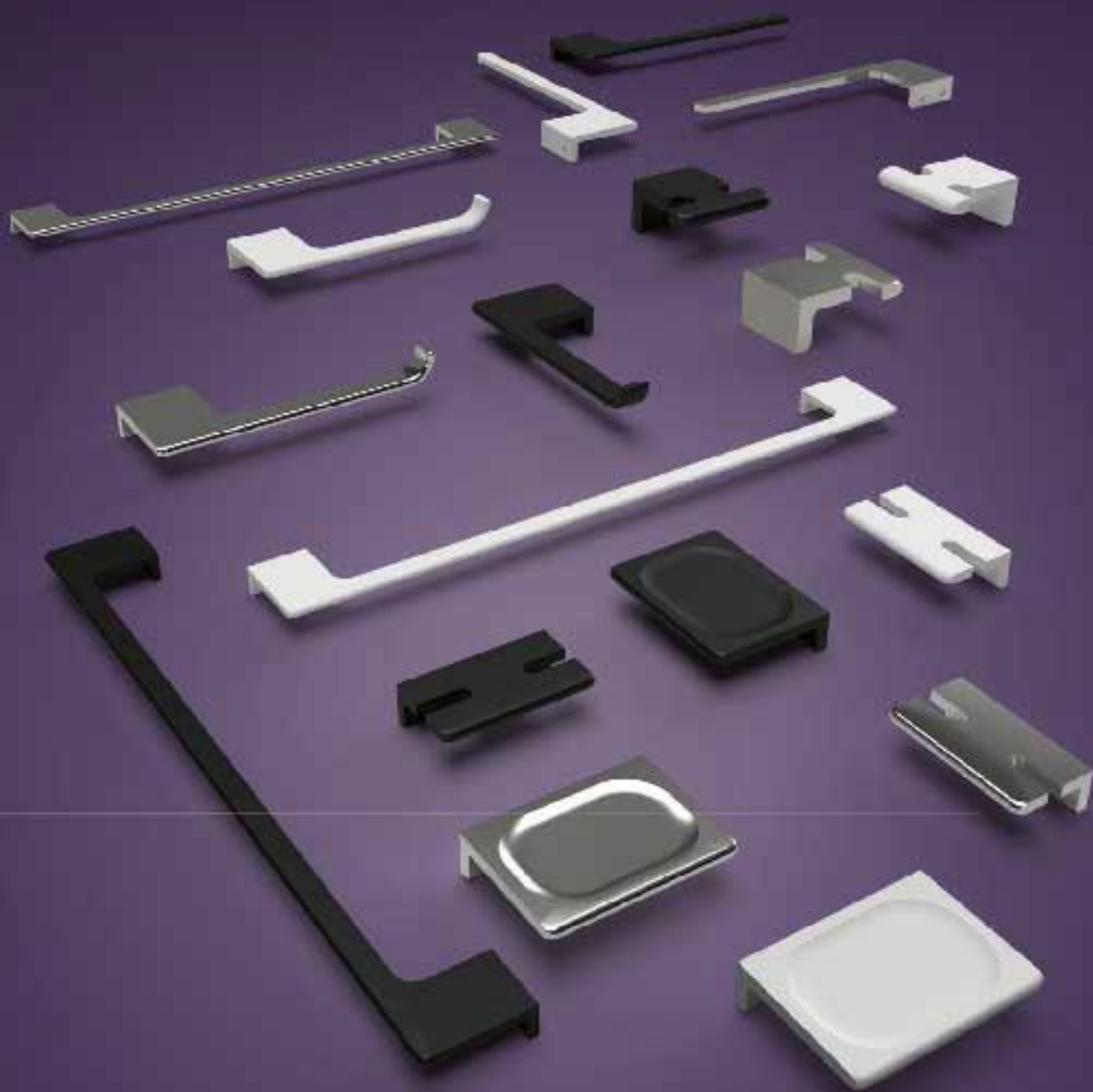

CR
Cromo



EB
Ébano



B
Polar

ACCESORIOS



Jaboneras.



Portapapel.



Cepilleros.



Toalleros.



Ganchos.



Ganchos multiusos.



Barra de seguridad residencial.



Rejillas.



Repisas.



Espejos.



Agarraderas de tina.



Tendedero retráctil.





HELVEX
BATHING



Garantía Helvex en acabado cromo de 10 años
y resto de acabados 2 años.

ACCESS CROMO

ACCESS

ACC-105

Cromo

\$ 2.046.00

Toallero de barra.



Dimensiones:
vista frontal

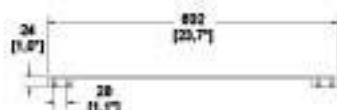

Dimensiones:
vista cenital

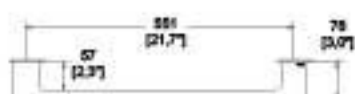

Acabado.

CR

ACCESS

ACC-106

Cromo

\$ 709.00

Gancho sencillo.



Dimensiones:
vista frontal

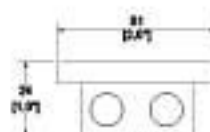

Dimensiones:
vista lateral

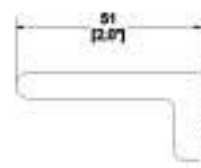

Acabado.

CR

ACCESS

ACC-107

Cromo

\$ 933.00

Portacepillos.



Dimensiones:
vista frontal

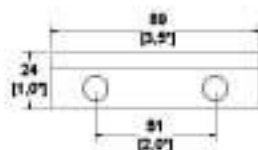

Dimensiones:
vista lateral

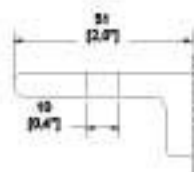

Acabado.

CR

ACCESS

ACC-108

Cromo

\$ 1.020.00

Jabonera.



Dimensiones:
vista frontal



Dimensiones:
vista lateral

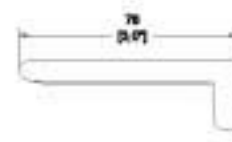

Acabado.

CR



ACCESS

ACC-109

Cromo

\$ 1.104.00

Toallero sencillo.



Dimensiones:
vista frontal

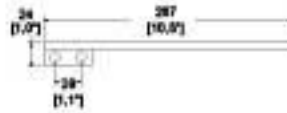

Dimensiones:
vista lateral

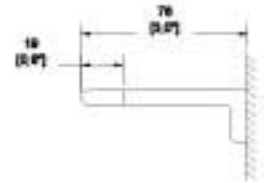

Acabado.



ACCESS

ACC-117

Cromo

\$ 1.426.00

Portapapel.



Dimensiones:
vista frontal

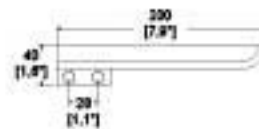

Dimensiones:
vista lateral

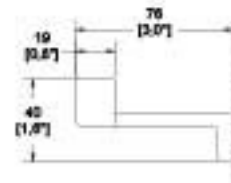

Acabado.



ACCESS POLAR

ACCESS

ACC-105-B

Polar

\$ 2.352.00

Toallero de barra.



Dimensiones:
vista frontal

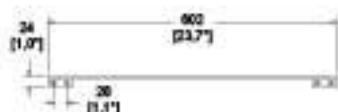

Dimensiones:
vista cenital

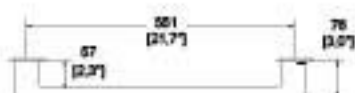

Acabado.

B

ACCESS

ACC-106-B

Polar

\$ 814.00

Gancho sencillo.



Dimensiones:
vista frontal

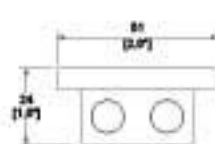

Dimensiones:
vista lateral

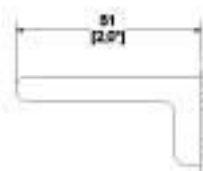

Acabado.

B

ACCESS

ACC-107-B

Polar

\$ 1.072.00

Portacepillos.



Dimensiones:
vista frontal

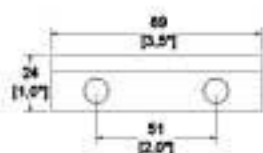

Dimensiones:
vista lateral

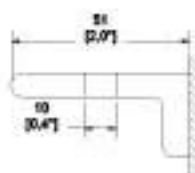

Acabado.

B

ACCESS

ACC-108-B

Polar

\$ 1.172.00

Jabonera.



Dimensiones:
vista frontal

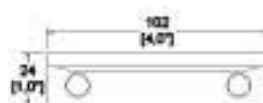

Dimensiones:
vista lateral

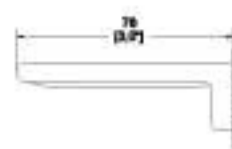

Acabado.

B

ACCESS
ACC-109-B
Polar

\$ 1.269.00

Toallero sencillo.



Dimensiones:
vista frontal

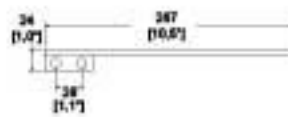

Dimensiones:
vista lateral

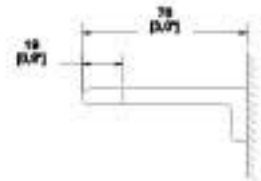

Acabado.

B

ACCESS
ACC-117-B
Polar

\$ 1.640.00

Portapapel.



Dimensiones:
vista frontal

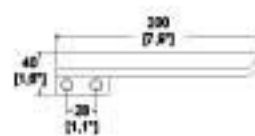

Dimensiones:
vista lateral

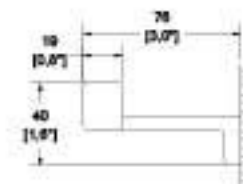

Acabado.

B



ACCESS ÉBANO

ACCESS ACC-105-EB Ébano

\$ 2.352.00

Toallero de barra.



Dimensiones:
vista frontal

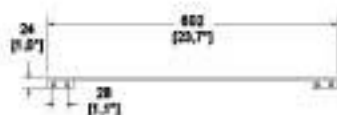

Dimensiones:
vista cenital

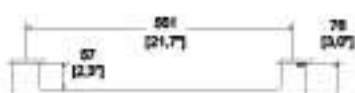

Acabado.



EB

ACCESS ACC-106-EB Ébano

\$ 814.00

Gancho sencillo.



Dimensiones:
vista frontal

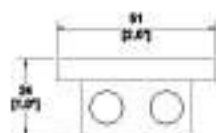

Dimensiones:
vista lateral

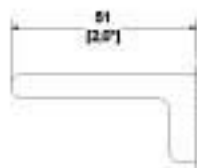

Acabado.



EB

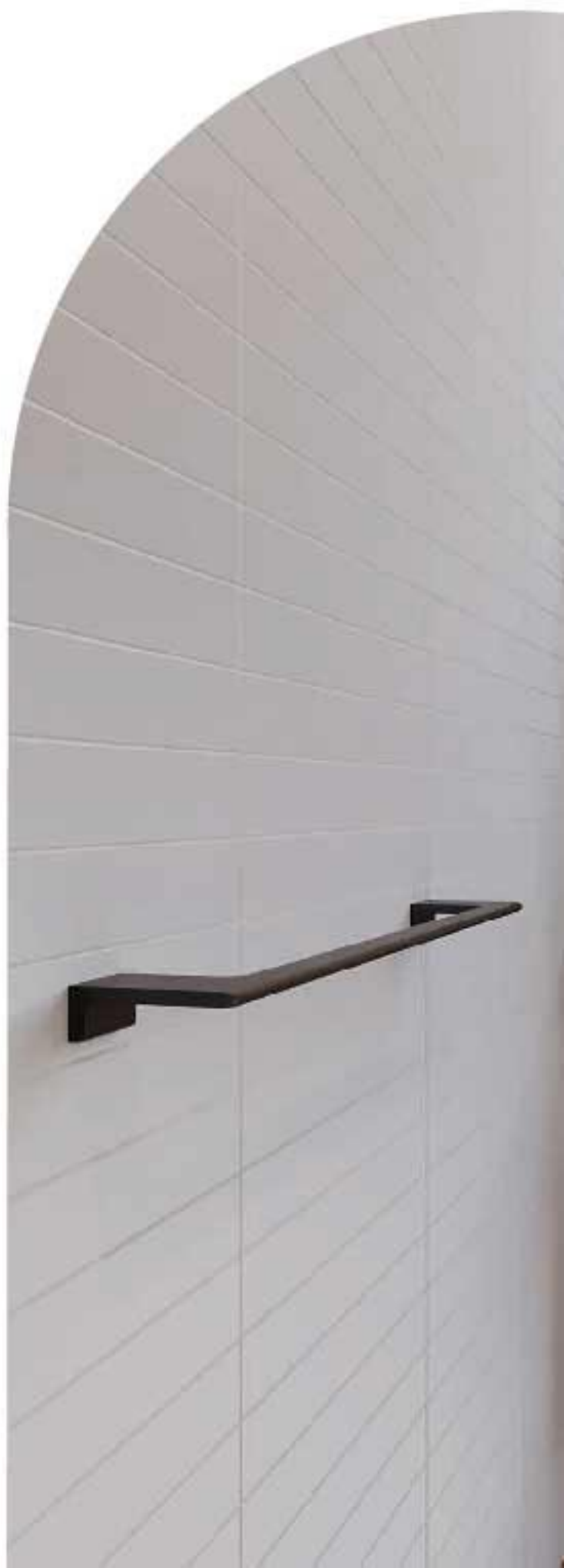

ACCESS
ACC-107-EB
Ébano

\$ 1.072.00

Portacepillos.



Dimensiones:
vista frontal

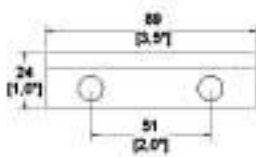

Dimensiones:
vista lateral

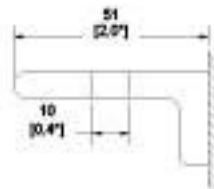

Acabado,



EB

ACCESS
ACC-108-EB
Ébano

\$ 1.172.00

Jabonera.



Dimensiones:
vista frontal

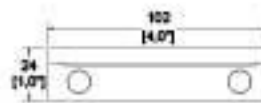

Dimensiones:
vista lateral

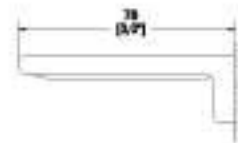

Acabado,



EB

ACCESS
ACC-109-EB
Ébano

\$ 1.269.00

Toallero sencillo.



Dimensiones:
vista frontal



Dimensiones:
vista lateral

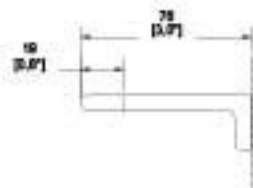

Acabado,



EB

ACCESS
ACC-117-EB
Ébano

\$ 1.640.00

Portapapel.



Dimensiones:
vista frontal

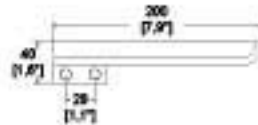

Dimensiones:
vista lateral

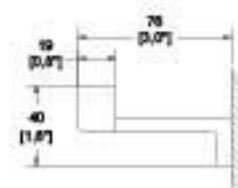

Acabado,



EB

CLÁSICA

34
Cromo

\$ 1.517.00

Portapapel vertical y/o de repuesto.



Dimensiones:
vista frontal

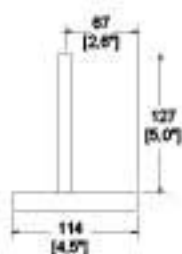

Dimensiones:
vista lateral

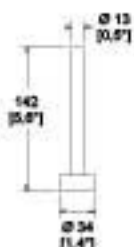

Acabado.

CR

CLÁSICA

100
Cromo

\$ 1.910.00

Jabonera de empotrar con agarradera. Incluye charola antirrobo.



Dimensiones:
vista frontal



Dimensiones:
vista lateral

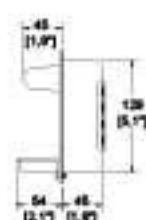

Acabado.

CR

CLÁSICA

101
Cromo

\$ 1.717.00

Jabonera de empotrar con agarradera. Incluye charola de acrílico.



Dimensiones:
vista frontal

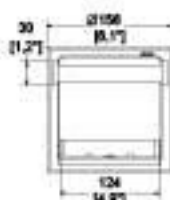

Dimensiones:
vista lateral



Acabado

CR



CLÁSICA

104
Cromo

\$ 1.730.00

Portapapel de empotrar.
Incluye tubo portapapel.



Dimensiones:
vista frontal

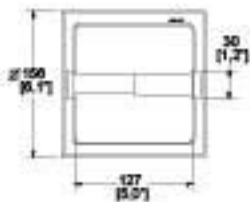

Dimensiones:
vista lateral



Acabado.

CR

CLÁSICA

105
Cromo

\$ 2.224.00

Toallero de barra.



Dimensiones:
vista frontal

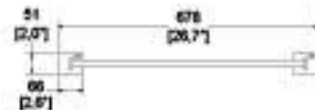

Dimensiones:
vista cenital

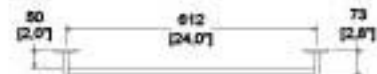

Acabado.

CR

CLÁSICA

105-45
Cromo

\$ 2.072.00

Toallero de barra de 45 cm.
Ideal para espacios reducidos.



Dimensiones:
vista frontal



Dimensiones:
vista cenital



Acabado.

CR

CLÁSICA

106
Cromo

\$ 743.00

Gancho doble.



Dimensiones:
vista cenital

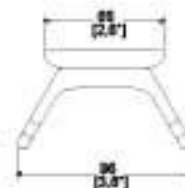

Dimensiones:
vista lateral

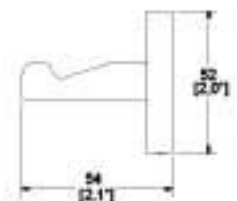

Acabado.

CR

CLÁSICA CROMO

CLÁSICA

107
Cromo

\$ 946.00

Portavaso cepillero.



Dimensiones:
vista cenital

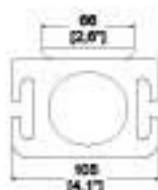

Dimensiones:
vista lateral

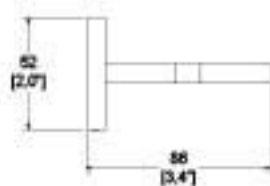

Acabado.



CR

CLÁSICA

108
Cromo

\$ 1,096.00

Jabonera.



Dimensiones:
vista cenital

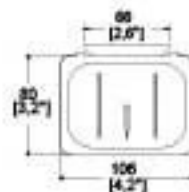

Dimensiones:
vista lateral

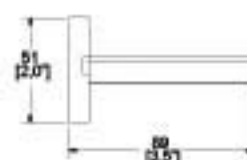

Acabado.



CR



CLÁSICA

109
Cromo

\$ 1,099.00

Toallero de argolla.



Dimensiones:
vista frontal

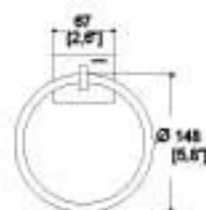

Dimensiones:
vista lateral

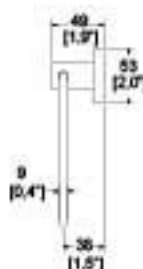

Acabado.



CR

CLÁSICA

110
Cromo

\$ 4.457.00

Portatoallas múltiple.



Dimensiones:
vista cenital



Dimensiones:
vista lateral



Acabado.



CR

CLÁSICA

114
Cromo

\$ 2.458.00

Portapapel de empotrar con cubierta.



Dimensiones:
vista frontal

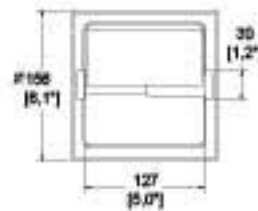

Dimensiones:
vista lateral



Acabado.



CR

CLÁSICA

115
Cromo

\$ 2.086.00

Portapapel de empotrar con tubo antirrobo.

Seguro antirrobo



Dimensiones:
vista frontal

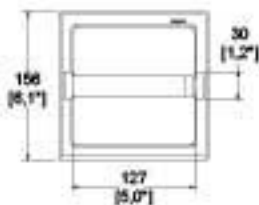

Dimensiones:
vista lateral

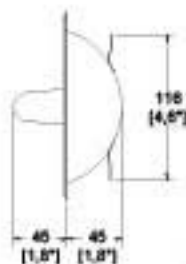

Acabado.



CR



CLÁSICA CROMO

CLÁSICA

117
Cromo

\$ 1,527.00

Portapapel.



Dimensiones:
vista frontal

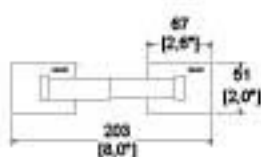

Dimensiones:
vista cenital

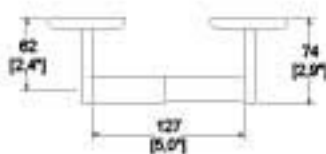

Acabado.



CR

CLÁSICA

122
Cromo

\$ 1,840.00

Tendedero retráctil,
longitud 3.25 m.

ACCESORIO
INSTITUCIONAL



Dimensiones:
vista frontal



Dimensiones:
vista lateral

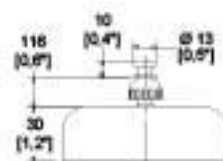

Carga máxima 2,5 kg.
Tendedero de uso para interiores.



CR

CLÁSICA

123
Cromo

\$ 696.00

Destapador.

ACCESORIO
INSTITUCIONAL



Dimensiones:
vista frontal

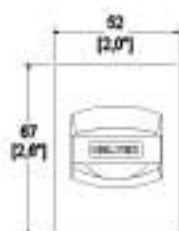

Dimensiones:
vista lateral

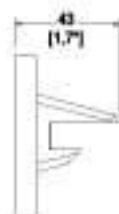

Acabado.



CR

CLÁSICA

124
Cromo

\$ 5,650.00

Portatoallas múltiple
con toallero.



Dimensiones:
vista frontal



Dimensiones:
vista cenital



Acabado.



CR

CLÁSICA

158
Cromo

\$ 4.788.00

Agarradera para tina con jabonera de rejilla, convertible a derecha o izquierda.

ACCESORIO INSTITUCIONAL



Dimensiones:
vista frontal

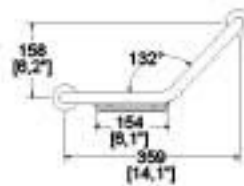

Dimensiones:
vista cenital

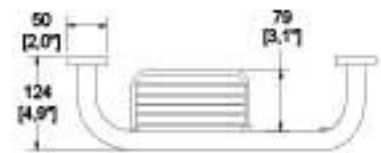

Carga máxima aplicada 100 kg.
máximo por un periodo de 5 minutos.



CLÁSICA

266
Cromo

\$ 968.00

Gancho multiusos reforzado.

ACCESORIO INSTITUCIONAL



Dimensiones:
vista frontal



Dimensiones:
vista lateral

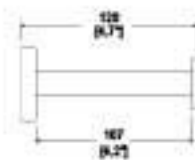

Soporta hasta 50 kg.



CLÁSICA II

205

Cromo

\$ 2.224.00

Toallero de barra.



Acabado.



CLÁSICA II

205-45

Cromo

\$ 2.072.00

Toallero de barra de 45 cm.
Ideal para espacios reducidos.



Acabado.



CLÁSICA II

206

Cromo

\$ 743.00

Gancho doble.



Dimensiones vista cenital

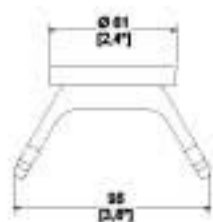

Dimensiones vista lateral

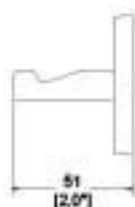

Acabado.



CLÁSICA II

207

Cromo

\$ 946.00

Portacepillos.



Dimensiones: vista frontal

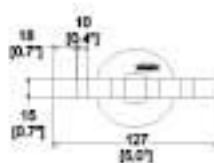

Dimensiones vista lateral

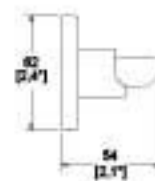

Acabado.



CLÁSICA II

208
Cromo

\$ 1.092.00

Jabonera.



Dimensiones:
vista cenital

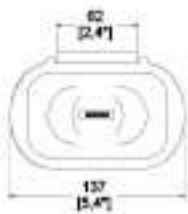

Dimensiones:
vista lateral

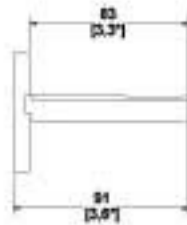

Acabado,

CR

CLÁSICA II

209
Cromo

\$ 1.099.00

Toallero de argolla.



Dimensiones:
vista frontal

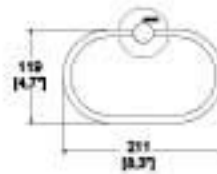

Dimensiones:
vista lateral

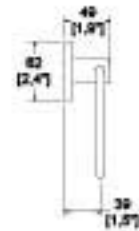

Acabado,

CR

CLÁSICA II

210
Cromo

\$ 4.457.00

Portatoallas múltiple.

ACCESORIO INSTITUCIONAL



Dimensiones:
vista frontal

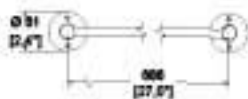

Dimensiones:
vista cenital

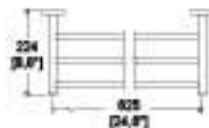

Acabado,

CR



CLÁSICA II

215
Cromo

\$ 2,098.00

Portapapel
con tubo antirrobo.

ACCESORIO
INSTITUCIONAL



Dimensiones:
vista cenital

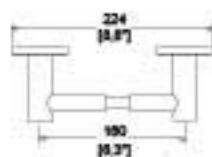

Dimensiones:
vista lateral

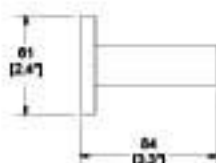

Acabado.



CR

CLÁSICA II

217
Cromo

\$ 1,527.00

Portapapel.



Dimensiones:
vista cenital

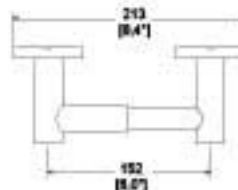

Dimensiones:
vista lateral

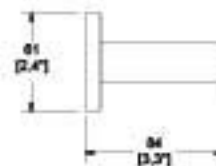

Acabado.



CR

CLÁSICA II

219
Cromo

\$ 3,359.00

Portapapel doble
con tubos antirrobo.

ACCESORIO
INSTITUCIONAL



Dimensiones:
vista cenital

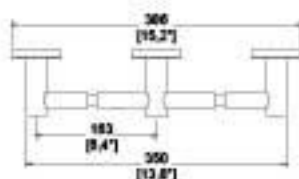

Dimensiones:
vista lateral

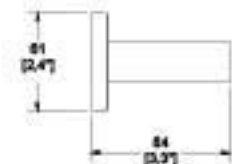

Acabado.



CR

CLÁSICA II

223
Cromo

\$ 692.00

Destapador.

ACCESORIO
INSTITUCIONAL



Dimensiones:
vista frontal

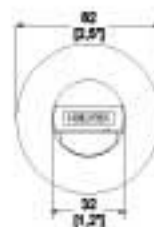

Dimensiones:
vista lateral

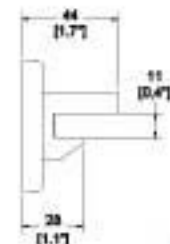

Acabado.



CR

PREMIER

15104

Cromo

\$ 1.769.00

Portapapel.



Dimensiones:
vista cenital



Dimensiones:
vista lateral

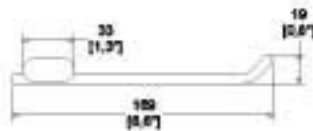

Acabado,



PREMIER

15105

Cromo

\$ 3.166.00

Toallero de barra.



Dimensiones:
vista cenital

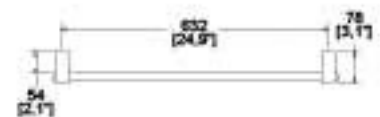

Dimensiones:
vista lateral



Acabado,



PREMIER

15106

Cromo

\$ 773.00

Gancho sencillo.



Dimensiones:
vista cenital

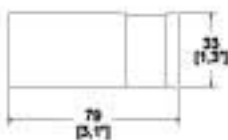

Dimensiones:
vista lateral

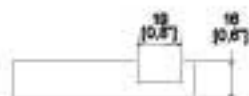

Acabado,



PREMIER

15107

Cromo

\$ 1.595.00

Portacepillos.



Dimensiones:
vista cenital

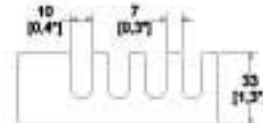

Dimensiones:
vista frontal

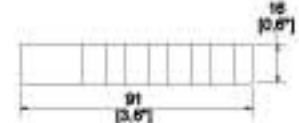

Acabado,



PREMIER

15108

Cromo

\$ 2.123.00

Jabonera.



Dimensiones:
vista cenital

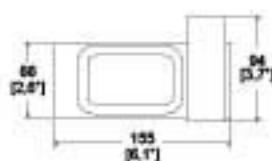

Dimensiones:
vista lateral



Acabado.



CR

PREMIER

15109

Cromo

\$ 1.708.00

Toallero sencillo.



Dimensiones:
vista cenital

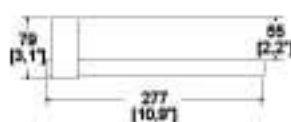

Dimensiones:
vista lateral



Acabado.



CR



PREMIER
15104-EB
Ébano

\$ 2.032.00

Portapapel.



Dimensiones:
vista cenital



Dimensiones:
vista lateral

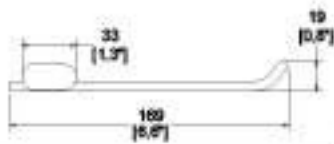

Acabado.



PREMIER
15105-EB
Ébano

\$ 3.641.00

Toallero de barra.



Dimensiones:
vista cenital

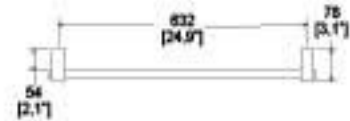

Dimensiones:
vista lateral

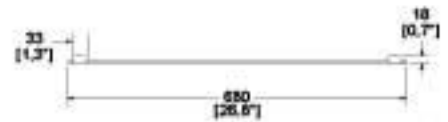

Acabado.



PREMIER
15106-EB
Ébano

\$ 889.00

Gancho sencillo.



Dimensiones:
vista cenital

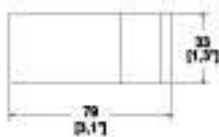

Dimensiones:
vista lateral

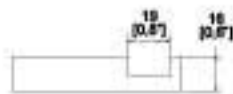

Acabado.



PREMIER
15107-EB
Ébano

\$ 1.822.00

Portacepillos.



Dimensiones:
vista cenital



Dimensiones:
vista frontal

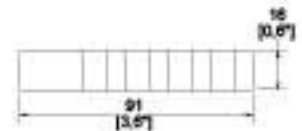

Acabado.



PREMIER ÉBANO

PREMIER

15108-EB

Ébano

\$ 2.440.00

Jabonera.



Dimensiones:
vista cenital

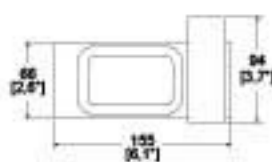

Dimensiones:
vista lateral



Acabado.



EB

PREMIER

15109-EB

Ébano

\$ 1.963.00

Toallero sencillo.



Dimensiones:
vista cenital

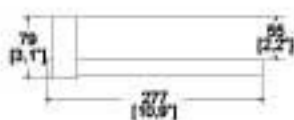

Dimensiones:
vista lateral



Acabado.



EB



NUVA

9105
Cromo

\$ 3.832.00

Toallero de barra.



Dimensiones:
vista frontal

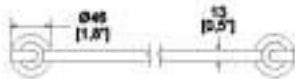

Dimensiones:
vista cenital

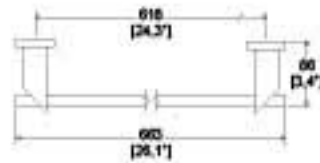

Acabado,

CR

NUVA

9106
Cromo

\$ 1.501.00

Gancho sencillo.



Dimensiones:
vista frontal

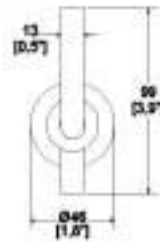

Dimensiones:
vista lateral



Acabado,

CR

NUVA

9107
Cromo

\$ 3.094.00

Vaso cepillero de cristal.



Dimensiones:
vista frontal

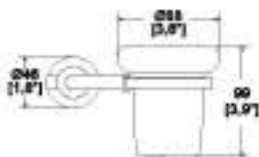

Dimensiones:
vista cenital

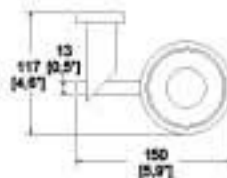

Acabado,

CR

NUVA

9109
Cromo

\$ 2.374.00

Toallero corto.



Dimensiones:
vista frontal



Dimensiones:
vista cenital

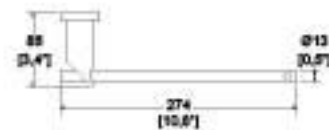

Acabado,

CR



NUVA

9117

Cromo

\$ 1.776.00

Portapapel.



Dimensiones:
vista frontal

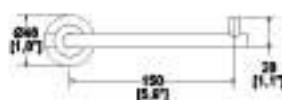

Dimensiones:
vista cenital

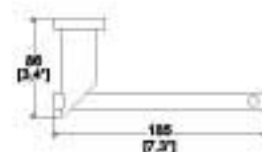

Acabado.



CR

NUVA

9124

Cromo

\$ 5.890.00

Portatoallas múltiple
con toallero.



Dimensiones:
vista cenital



Dimensiones:
vista lateral

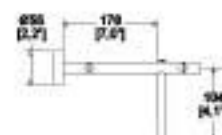

Acabado.



CR

NUVA CROMO

NUVA

9126

Cromo

\$ 5.351.00

Repisa de cristal de 60 cm.



Dimensiones:
vista cenital

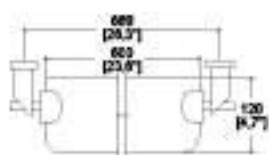

Dimensiones:
vista lateral

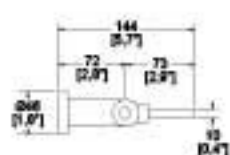

Acabado,



CR



NUVA

9128

Cromo

\$ 2.965.00

Jabonera.



Dimensiones:
vista cenital

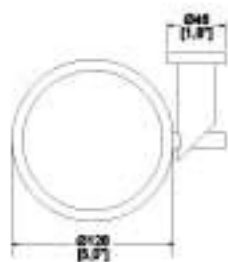

Dimensiones:
vista lateral

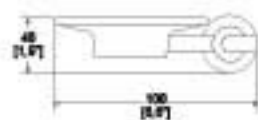

Acabado,



CR



EXPLORA
HOT-105
Cromo

\$ 2.433.00

Toallero de barra.



Dimensiones:
vista frontal



Dimensiones:
vista cenital



Acabado.



EXPLORA
HOT-105-45
Cromo

\$ 2.266.00

Toallero de barra de 45 cm.
Ideal para espacios reducidos.



Dimensiones:
vista frontal

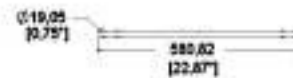

Dimensiones:
vista cenital

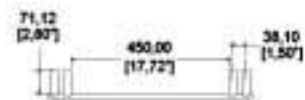

Acabado.



EXPLORA
HOT-106
Cromo

\$ 821.00

Gancho sencillo.



Dimensiones:
vista cenital

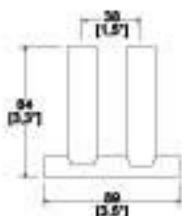

Dimensiones:
vista lateral



Acabado.



EXPLORA
HOT-107
Cromo

\$ 1.191.00

Portacepillos.



Dimensiones:
vista cenital

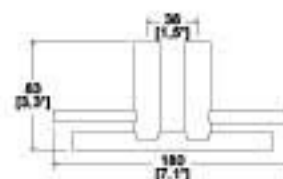

Dimensiones:
vista lateral



Acabado.



EXPLORA CROMO

EXPLORA

HOT-108

Cromo

\$ 1.186.00

Jabonera.



Dimensiones:
vista cenital

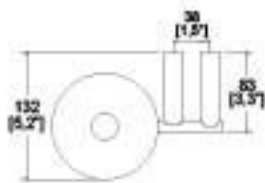

Dimensiones:
vista lateral

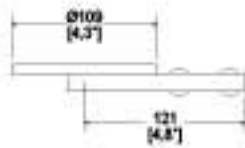

Acabado.



CR

EXPLORA

HOT-109

Cromo

\$ 1.618.00

Toallero sencillo.



Dimensiones
vista frontal



Dimensiones
vista cenital

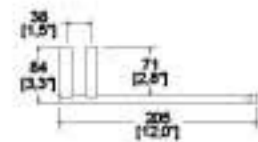

Acabado.



CR



EXPLORA

HOT-17

Cromo

\$ 1.559.00

Portapapel.



Dimensiones
vista frontal



Dimensiones
vista cenital

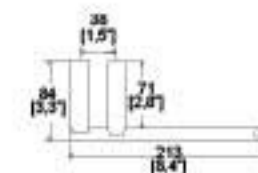

Acabado.



CR

KONOS

2104

Cromo

\$ 1.448.00

Portapapel.



Dimensiones:
vista frontal

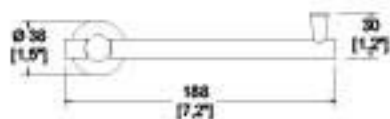

Dimensiones:
vista cenital

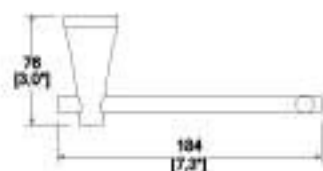

Acabado.



CR

KONOS

2105

Cromo

\$ 2.332.00

Toallero de barra.



Dimensiones:
vista cenital

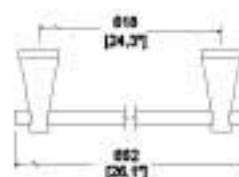

Dimensiones:
vista lateral

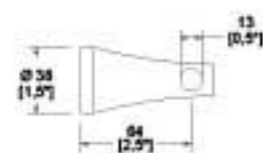

Acabado.



CR

KONOS

2106

Cromo

\$ 941.00

Gancho doble.



Dimensiones:
vista frontal

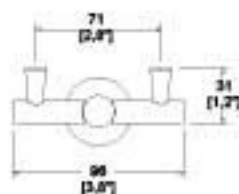

Dimensiones:
vista lateral

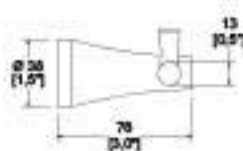

Acabado.



CR

KONOS

2107

Cromo

\$ 1.581.00

Portacepillos.



Dimensiones:
vista frontal

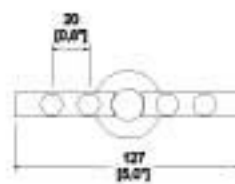

Dimensiones:
vista lateral

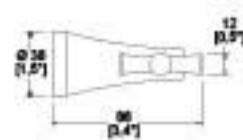

Acabado.



CR

KONOS CROMO

KONOS

2108

Cromo

\$1.602.00

Jabonera.



Dimensiones:
vista cenital



Dimensiones:
vista lateral



Acabado.



CR

KONOS

2109

Cromo

\$1.527.00

Toallero sencillo.



Dimensiones:
vista frontal



Dimensiones:
vista lateral

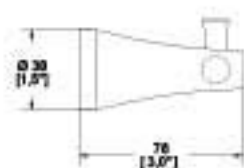

Acabado.



CR



KÚBICA

14104
Cromo

\$ 1.898.00

Portapapel.



Dimensiones:
vista frontal

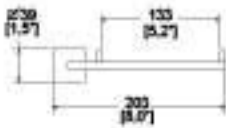

Dimensiones:
vista cenital

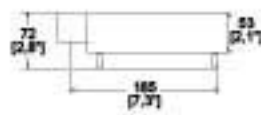

Acabado.



CR

KÚBICA

14105
Cromo

\$ 4.135.00

Toallero de barra.



Dimensiones:
vista frontal

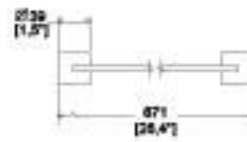

Dimensiones:
vista cenital

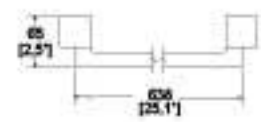

Acabado.



CR

KÚBICA

14106
Cromo

\$ 1.608.00

Gancho doble.



Dimensiones:
vista cenital

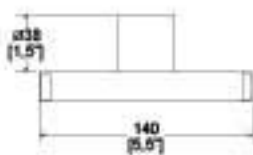

Dimensiones:
vista lateral

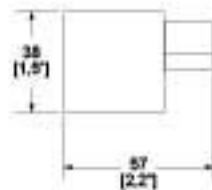

Acabado.



CR



KÚBICA CROMO

KÚBICA

14107

Cromo

\$ 2.377.00

Portacepillos.



Dimensiones:
vista cenital

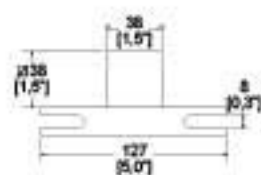

Dimensiones:
vista lateral

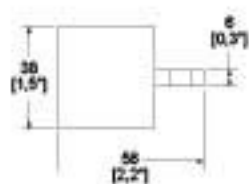

Acabado.



CR

KÚBICA

14108

Cromo

\$ 3.181.00

Jabonera.



Dimensiones:
vista cenital

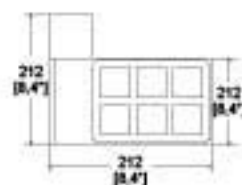

Dimensiones:
vista lateral

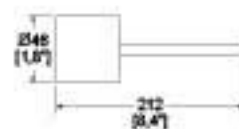

Acabado.



CR



KÚBICA

14109

Cromo

\$ 2.545.00

Toallero sencillo.



Dimensiones:
vista cenital

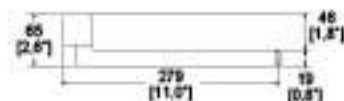

Dimensiones:
vista lateral

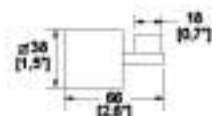

Acabado.



CR

MÁXIMA

20105

Cromo

\$ 3.166.00

Toallero de barra.



Dimensiones:
vista frontal

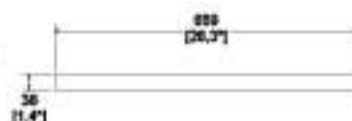

Dimensiones:
vista cenital

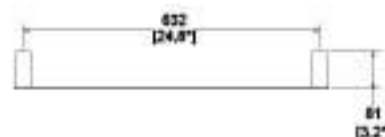

Acabado.



CR

MÁXIMA

20106

Cromo

\$ 773.00

Gancho sencillo.



Dimensiones:
vista frontal

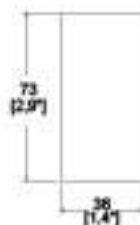

Dimensiones:
vista lateral

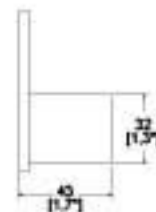

Acabado.



CR

MÁXIMA

20109

Cromo

\$1708.00

Toallero sencillo.



Dimensiones:
vista frontal

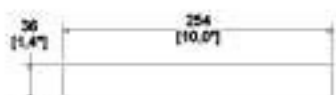

Dimensiones:
vista canital



Acabado.



MÁXIMA

20117

Cromo

\$1769.00

Portapapel.



Dimensiones:
vista frontal

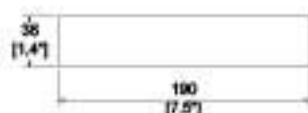

Dimensiones:
vista canital



Acabado.

